

RealLink for Windows

V3.0

User Manual

All trademarks including but not limited to brand names, logos and product names referred to in this document are trademarks or registered trademarks of Northgate Information Solutions UK Limited (Northgate) or where appropriate a third party.

This document is protected by laws in England and other countries. Unauthorised use, transmission, reproduction, distribution or storage in any form or by any means in whole or in part is prohibited unless expressly authorised in writing by Northgate. In the event of any such violations or attempted violations of this notice, Northgate reserves all rights it has in contract and in law, including without limitation, the right to terminate the contract without notice.

© Copyright Northgate Information Solutions UK Limited, 2010.

Document No. UM70006276DR1
August 2010

Northgate Information Solutions UK Limited
Peoplebuilding 2
Peoplebuilding Estate
Maylands Avenue
Hemel Hempstead
Herts
HP2 4NW
Tel: +44 (0)1442 232424
Fax: +44 (0)1442 256454
www.northgate-is.com

Contents

Chapter 1 About this Manual

| | |
|------------------------------|----|
| Purpose of this Manual | 12 |
| Related Documents | 13 |
| Glossary | 14 |
| Conventions | 16 |
| User Comments | 18 |

Chapter 2 Introduction to RealLink

| | |
|--|----|
| Overview | 20 |
| RealLink Concepts | 21 |
| Configuration Files | 21 |
| The Terminal Window | 21 |
| The User Interface Management System | 22 |

Chapter 3 Installation

| | |
|--|----|
| Introduction | 25 |
| Installing the PC Software | 26 |
| Hardware and Software Requirements | 26 |
| Using the Setup Program | 27 |
| RealLink Files | 30 |
| Configuring RealLink | 32 |
| The RFW.INI File | 32 |
| Command Line Parameters | 32 |
| SovereignX DLLs | 33 |
| Host Software | 34 |
| Reality Item Size | 34 |

Chapter 4 Getting Started

| | |
|----------------------------|----|
| Introduction | 35 |
| Setting up a Session | 36 |

Chapter 5 Using RealLink

| | |
|--|----|
| Starting RealLink | 39 |
| The Status Bar | 39 |
| Connecting to a Host | 40 |
| Terminating a Session | 42 |
| Closing RealLink | 42 |
| Using the Mouse and the Keyboard | 43 |
| Editing Functions | 43 |
| Advanced Editing Functions | 45 |
| Mouse Shortcuts | 48 |
| Function Keys | 48 |
| History Pages | 49 |
| The Pause Key | 50 |
| Entering Diacritical Characters | 50 |

| | |
|---------------------------------------|----|
| The Command Line Editor | 51 |
| Repeating your Last Command | 51 |
| Repeating a Previous Command | 51 |
| Changing a Command | 52 |
| Selecting Text to Edit | 52 |
| Pre-loaded Commands | 52 |
| Using Replace to Edit Commands | 53 |
| Obtaining Help | 55 |
| Help Menu | 55 |
| Context-sensitive Help | 56 |
| Reality Help | 56 |
| Running Applications | 57 |
| Controlling UIMS Applications | 57 |
| Resetting the Terminal Emulator | 59 |
| Printing | 60 |
| Printer Setup | 60 |
| Print Window | 62 |
| Print Selection | 62 |
| Direct Printing | 62 |
| Spooled Printing | 62 |
| Printing to a File | 62 |

Chapter 6 Setting up Sessions

| | |
|---|----|
| Configuration Files | 66 |
| Creating a New Configuration File | 66 |
| Modifying an Existing Configuration | 67 |
| Saving your Configuration File | 68 |
| The Default Configuration | 69 |
| Setting up a Network Session | 70 |
| Setting Up an Asynchronous Session | 71 |
| Asynchronous Dialog | 71 |
| Baud Rate | 71 |
| Parity | 71 |
| Data Format | 71 |
| Flow Control | 72 |
| Stop bits | 72 |
| Drop DTR on Exit | 72 |
| Terminal Emulation | 73 |
| Prism Emulation | 73 |
| ANSI Emulations | 74 |
| VT220 Emulation | 74 |
| Terminal Preferences | 76 |
| Page Size | 76 |
| History Pages | 76 |
| Function Keys | 76 |
| Cursor Type | 77 |
| Other Options | 77 |

| | |
|--|-----|
| Screen Attributes..... | 79 |
| Attribute Mapping..... | 79 |
| Font Control..... | 80 |
| Chapter 7 File Transfer | |
| Introduction..... | 84 |
| LanFTU..... | 85 |
| Reality Host Utilities..... | 89 |
| HOST-WS..... | 89 |
| WS-HOST..... | 90 |
| PASS-DOS and SPASS-DOS | 92 |
| UNIX Host Utilities | 95 |
| Chapter 8 Macros | |
| Introduction..... | 98 |
| Script Objects..... | 98 |
| Menu Commands..... | 98 |
| Toolbars..... | 99 |
| Function-key and Mouse Button Definitions..... | 99 |
| Writing a Simple Macro..... | 100 |
| Loading a Macro | 103 |
| The Macro Select Command | 103 |
| Loading a Macro from the Command Line..... | 104 |
| The Script Language | 105 |
| Object Definitions..... | 105 |
| Flow Control | 107 |
| Strings..... | 109 |
| Comments | 109 |
| Command Reference..... | 97 |
| Reserved Words..... | 97 |
| Error Messages | 98 |
| Load-time Errors..... | 98 |
| Run-time Errors..... | 98 |
| Tokens | 99 |
| Chapter 9 Problem Solving | |
| Introduction..... | 101 |
| Problems Running RealLink..... | 102 |
| Asynchronous Communication Problems..... | 104 |
| Problems with LAN Sessions | 106 |
| File Transfer Problems | 107 |
| LanFTU..... | 107 |
| HOST-WS and WS-HOST..... | 108 |
| PASS-DOS and SPASS-DOS | 108 |

Appendix A The RFW.INI File

| | |
|-------------------------------------|-----|
| The Structure of the INI File | 111 |
| [RealLink] Section | 110 |
| [Editline] Section | 114 |
| [SaveCmds] Section | 115 |
| [SaveReps] Section | 115 |
| DLL Sections | 116 |
| [executives] Section | 116 |
| [macros] Section | 116 |
| [WLANFTU] Section | 117 |
| [rfwprint.dll] Section | 117 |
| [CharacterSets] Section | 117 |
| [CharacterMappings] Section | 117 |
| Key Codes | 110 |

Appendix B ANSI Escape Sequences

| | |
|----------------------------------|-----|
| Supported Escape Sequences | 113 |
| Page Manipulation Commands | 121 |
| MDDPL | 121 |
| MDSDF | 121 |
| Video Attributes | 123 |
| SGR | 123 |
| RealLink Escape Sequences | 124 |
| Append | 124 |
| Caps Lock Control | 124 |
| Clear History | 124 |
| Copy | 124 |
| Copy Table | 124 |
| Copy Window | 124 |
| Draw | 125 |
| Draw Rectangle | 127 |
| Fill Rectangle | 127 |
| MDISTEM | 128 |
| MDRDS | 129 |
| Num Lock Control | 129 |
| Paste | 129 |
| PC Status Report | 129 |
| Process Attributes | 130 |
| Screen Update | 130 |
| Set Selection | 130 |
| Stream | 131 |

Appendix C File Transfer Filters

| | |
|--|-----|
| Filters | 133 |
| Filter Items | 133 |
| Filter Attributes | 133 |
| Character Translation Attributes | 134 |

| | |
|------------------------|-----|
| HOST-WS Filters | 134 |
| WS-HOST Filters | 135 |
| The DIF Format | 138 |
| DIF header items | 138 |

Appendix D Connecting via a Terminal Server

| | |
|---------------------------------------|-----|
| Configuring the Terminal Server | 140 |
| Configuring the Host | 141 |

Appendix E Application Help

| | |
|------------------------------------|-----|
| The Help Application Command | 143 |
| Context-sensitive Help | 143 |
| Writing a Help Application..... | 143 |

Appendix F Dynamic Data Exchange

| | |
|-------------------------------------|-----|
| Introduction | 147 |
| Clients and Servers..... | 147 |
| Topics and Items | 147 |
| DDE Messages | 147 |
| Configuring RealLink for DDE | 148 |
| Using DDE..... | 149 |
| Initiating a DDE Conversation | 149 |
| Terminating a DDE Conversation..... | 149 |
| Sending Data to RealLink..... | 149 |
| Obtaining Data from RealLink | 149 |
| Controlling RealLink | 152 |

Index

List of Figures

| | |
|--|----|
| Figure 5-1. RealLink Application Window | 39 |
| Figure 5-2. Connect Dialog | 40 |
| Figure 5-3. Configure Table Dialog | 46 |
| Figure 5-4. Set Coordinate Format Dialog | 47 |
| Figure 5-5. Command Line Editor | 51 |
| Figure 5-6. Resume Dialog | 57 |
| Figure 5-7. Restore Key Dialog | 58 |
| Figure 5-8. Send Restore Key As Dialog | 59 |
| Figure 5-9. Printer Font Dialog | 61 |
| Figure 5-10. Stream to File Dialog | 63 |
| Figure 6-1. Setup Menu | 65 |
| Figure 6-2. File Open Dialog | 67 |
| Figure 6-3. File Save As Dialog | 68 |
| Figure 6-4. Communications Dialog..... | 70 |
| Figure 6-5. Asynchronous Dialog | 71 |

| | | |
|-------------|--|-----|
| Figure 6-6. | Terminal Emulation Dialog..... | 73 |
| Figure 6-7. | Terminal Preferences Dialog..... | 76 |
| Figure 6-8. | Attribute Mapping Dialog..... | 80 |
| Figure 7-1. | LanFTU Parameter Selection Dialog..... | 85 |
| Figure 7-2. | LanFTU Browse Dialog..... | 87 |
| Figure 7-3. | RZ File Transfer Dialog..... | 95 |
| Figure 7-4. | File Transfer Path Dialog..... | 95 |
| Figure 7-5. | SZ File Transfer Dialog..... | 96 |
| Figure 8-1. | Macro Select Dialog..... | 103 |
| Figure 8-2. | Pull-down and Cascading Menus..... | 106 |

List of Tables

| | | |
|------------|---|-----|
| Table 2-1. | Keys for Horizontal Scrolling..... | 21 |
| Table 5-1. | Function Keys..... | 48 |
| Table 5-2. | Direct Print Modes..... | 61 |
| Table 6-1. | VT220 Key Equivalents..... | 74 |
| Table 7-1. | File Transfer Utilities..... | 84 |
| Table 8-1. | Message Box Styles..... | 112 |
| Table A-1. | Key Codes..... | 110 |
| Table A-2. | Key Modifiers..... | 111 |
| Table B-1. | ANSI Escape Sequences..... | 113 |
| Table B-2. | Additional Functions for DEC VT220 Support..... | 118 |
| Table B-3. | Colour Options..... | 126 |
| Table F-1. | DDE Messages..... | 147 |

Chapter 1

About this Manual

This chapter defines the purpose and intended readership of this manual, and outlines the contents of each chapter. Conventions and references used in the manual are also listed.

Purpose of this Manual

RealLink for Windows provides the Microsoft Windows user with a terminal emulator for connecting to various types of host system. In particular, RealLink provides features aimed at the users of UNIX, Reality, Sovereign and SovereignX. This manual is intended for the user of a Northgate Personal Computer, or an IBM PC or 100% compatible, and describes the operating procedures for RealLink. It is assumed that the user is familiar with Microsoft Windows, and with the use of UNIX, Reality or Sovereign on a normal terminal.

This manual contains the following chapters and appendices:

Chapter 1, About this Manual.

Chapter 2, Overview, provides a description of RealLink.

Chapter 3, Installation, tells you how to install RealLink on your PC and how to configure Reality accounts to use the UIMS DataBasic API.

Chapter 4, Getting Started, tells you how to get up and running as quickly as possible.

Chapter 5, Using RealLink, describes how to start RealLink, connect to a host system and use the various features of the RealLink terminal emulator.

Chapter 6, Setting up Sessions, describes in detail the configuration file options.

Chapter 7, File Transfer, describes the file transfer utilities provided with and supported by RealLink.

Chapter 8, Macros, describes how to write RealLink macros, and gives full details of the RealLink macro language and the commands you can use.

Chapter 9, Problem Solving, describes some of the more common operating problems encountered and suggests how they might be overcome.

Appendix A, The RFW.INI File, describes the RFW.INI file and the configuration options that it offers. It also lists the key codes for the keys which can be used when defining keys in this file.

Appendix B, ANSI Escape Sequences, lists the escape sequences that are recognised by a Prism terminal in ANSI Mode.

Appendix C, File Transfer Filters, describes how to create your own filters for use with the HOST-WS and WS-HOST commands, and provides additional information about the PASS-DOS command.

Appendix D, Connection via a Terminal Server, describes how to configure a terminal server so that you can transfer files to and from a UNIX host using the Zmodem file transfer commands.

Appendix E, Application Help, describes how you can use RealLink to display on-line help for your applications.

Appendix F, Dynamic Data Exchange, describes how other Windows applications can communicate with RealLink by means of Dynamic Data Exchange (DDE).

Related Documents

Microsoft Windows User's Guide
PCI Standard Network Interface, Installation Guide
UNIX Connect, System Administration Guide

Prism Terminal Manuals

Models 12120, 12140, 12121 and 12141 Terminal Reference Manual
Models 12120, 12140, 12121 and 12141 Programmer's Reference Manual

Reality Manuals

Volumes 1 to 4.

SovereignX Manuals

Volume 2.

UIMS Manuals

DataBasic API, Reference Manual
DataBasic API, Quick Reference Guide
DataBasic API, Programmer's Guide

Glossary

The following terms and abbreviations are used in this manual:

API

Application Programming Interface. The functions and subroutines that provide the application programmer with access to a particular subsystem.

DDE

Dynamic Data Exchange - a message exchange protocol used in the Microsoft Windows environment.

Ethernet

A widely-used local area network standard.

GUI

Graphical User Interface.

Hybrid Application

A character-display application which has been modified to use the **UIMS API** to exploit some **GUI** functionality.

LAN

Local Area Network.

PCi

PC Integration.

Reality Environment

The Northgate Reality operating environment.

SNI

Standard Network Interface, part of the Northgate PC Integration software.

Solid Colour

A colour which is directly supported by your display adapter. Non-solid colours are produced by using patterns of coloured dots to simulate colours that are not directly supported. In order to ensure readability, RealLink uses only solid colours when displaying text in its **Terminal window**.

Terminal page

The equivalent of the screen of a normal terminal. All output directed to the screen by an application goes to the terminal page, and any cursor positioning commands are relative to the top left-hand corner of this page. Note that this is not the same as the **Terminal window**, which might not be displaying any part of the terminal page. See Chapter 2 for more information.

Terminal window

The area of the RealLink window which is inside the menu bar, any scroll bars and the window's border.

UIMS

User Interface Management System.

UIMS Application

An application which uses the **UIMS API** to fully exploit the Windows Graphical User Interface.

UIMS API

The Application Programming Interface for the Northgate User Interface Management System. The functions and subroutines that provide the application programmer with access to the **UIMS** functionality.

Conventions

This manual uses the following conventions:

| | |
|------------------|---|
| Text | Bold text shown in this typeface is used to indicate input which must be typed at the terminal. |
| Text | Text shown in this typeface is used to show text that is output to the screen. |
| Bold text | Bold text in syntax descriptions represents characters typed exactly as shown. For example: RFW |
| <i>Text</i> | Characters or words in this italic font indicate parameters which must be supplied by the user. For example, in <i>RFW filename</i> the parameter <i>filename</i> is italicised to indicate that you must supply the name of an actual file on your system. Italic text is also used for titles of documents referred to by this document. |
| {Braces} | Braces enclose options and optional parameters. For example, in RFW {<i>config-file</i>} the parameter <i>config-file</i> is placed in braces to indicate that you can supply the name of an actual file, but that you do not have to. |
| [param param] | Parameters shown separated by vertical lines within square brackets in syntax descriptions indicate that at least one of these parameters must be selected. For instance, /W[0 1] indicates that either a 0 or a 1 must follow the /W switch (but not both). |
| ... | In syntax descriptions, indicates that the parameters preceding can be repeated as many times as necessary. |
| SMALL CAPITALS | Small capitals are used for the names of keys such as RETURN. |
| CTRL+X | Two (or more) key names joined by a plus sign (+) indicate a combination of keys, where the first key(s) must be held down while the second (or last) is pressed. For example, CTRL+X indicates that the CTRL key must be held down while the X key is pressed. |
| Enter | To enter means to type text then press RETURN. For instance, 'Enter the WHO command' means type WHO , then press return. |

In general, the RETURN key (shown as ENTER or ↵ on some keyboards) must be used to complete all terminal input unless otherwise specified.

Type To type text or a key sequence means to press the keys concerned, but not to press RETURN afterwards.

Press Press single key or key combination but do not press RETURN afterwards.

0xnn This denotes the hexadecimal value, *nn*. For example, 0xA9 denotes the hexadecimal value A9 (decimal 169).



This symbol indicates how to carry out a task from the keyboard.



This symbol indicates how to carry out a task with the mouse.

User Comments

A Comment Sheet is included at the front of this manual. If you find any errors or have any suggestions for improvements in the manual please complete and return the form. If it has already been used, send your comments to CJPS Technical Publications at the address on the title page, or email CJPSTECHPUBS@northgate-is.com.

Chapter 2

Introduction to RealLink

This chapter provides an overview of RealLink for Windows.

Overview

RealLink provides the following features for the Microsoft Windows user:

- Emulation of Northgate Prism P12 and P14 terminals (including ANSI terminal emulation). This emulation includes printer support, plus up to 255 history pages (depending on available memory) and mapping of monochrome terminal attributes into colour. Extensions that provide support for Northgate Sovereign and SovereignX systems are available separately.
- Various ways of printing to a Windows printer are available, including: screen dump of the RealLink window; printing of selected text from the RealLink window or any back-page; direct printing from a host application; and PORT-DESPOOL.
- Connection can be via asynchronous link and/or local area network.

Note: In most cases, the PC*i* Standard Network Interface (supplied with your RealLink package) must be loaded before network connections can be used.

- Several instances of RealLink can be run at the same time, thus allowing simultaneous access to different systems or multiple connections to the same system.
- Data can be transferred between Reality and DOS, and UNIX and DOS in a variety of formats to suit particular requirements.
- A mouse can be used to select from application menus, with no changes to existing host applications.
- Macros can be written to automate frequent or complicated tasks.
- Other Windows applications can communicate with RealLink by using the Windows Dynamic Data Exchange (DDE) protocol.
- An integral User Interface Management System (UIMS) allows host applications to be written to take advantage of the Windows Graphical User Interface. Existing applications can easily be converted to use certain UIMS features.
- Other Windows applications can be launched and driven from within host applications. DOS directories can be created and deleted, and DOS files deleted.

Full functionality of the RealLink software resides partly on the PC and partly on the host system. The RealLink package consists of:

- PC software providing terminal emulation. This is supplied on CD ROM.
- Host software that, when used in conjunction with the RealLink PC software, provides file transfer facilities and allows you to run applications which use the UIMS. This is supplied with Reality V9.0.

Note: The UIMS host software includes DataBasic subroutines which allow your host applications to launch and drive other Windows applications.

RealLink Concepts

Configuration Files

The configuration for a connection to a host is determined by the settings in a configuration (CFG) file. This specifies all the relevant parameters for that session, including the following:

- Whether the connection will be made via an asynchronous link or via the local area network.
- To which host connection will be made.
- For an asynchronous session, which serial port will be used and the correct communications set-up.
- Which type of terminal emulation will be used.
- The number of lines and columns on the terminal page (see below).

Note: Refer to Chapter 6 for details of the parameters that can be set for each session.

The Terminal Window

The terminal window is the area of the RealLink window which is inside the window border and below the menu bar, but excluding any scroll bars. This area is used for typing input to the host and for displaying text output from the host. The default configuration gives you an 80 character by 25 line display in the default font with no vertical scroll bar.

The number of lines and columns that can be displayed is determined by the font size and the size of the terminal window, while the latter is limited in size by the screen resolution and whether or not scroll bars are displayed. For example, on a standard VGA display (640 by 480 pixels), 80 characters can only be displayed in the default font if the terminal window occupies the whole of the available screen width. Adding a vertical scroll bar reduces the width of the terminal window by two columns.

When you start RealLink, the terminal window is always made wide enough to display 80 characters in the default font, with the vertical scroll bar disabled. If, however, the terminal window is not wide enough to display the required number of characters, RealLink will automatically supply a horizontal scroll bar at the bottom of the window. This will happen if you, for example, select a wider font, select 132-column mode, or reduce the width of the window. The height of the RealLink window is automatically adjusted to allow for the presence or absence of a horizontal scroll bar, so that the correct number of lines is always displayed. When the horizontal scroll bar is present, you can use the following key combinations to scroll the terminal window horizontally:

Table 2-1. Keys for Horizontal Scrolling

| Key Combination | Result |
|------------------|--|
| CTRL+PAGE UP | Scrolls left by one character less than the width of the terminal window. |
| CTRL+ALT+PAGE UP | Scrolls left one character. |
| CTRL+PAGE DOWN | Scrolls right by one character less than the width of the terminal window. |

| |
|--------------------|
| CTRL+ALT+PAGE DOWN |
|--------------------|

| |
|------------------------------|
| Scrolls right one character. |
|------------------------------|

If the height of the terminal window is reduced (or if a larger font is selected), only part of the terminal page can be displayed. Normally, the bottom part of the page is shown, but you can use the PAGE UP and PAGE DOWN keys, or the vertical scroll bar, to scroll up if required. Note that the vertical scroll bar is not provided automatically; but can be enabled with the Terminal Preferences command on the Setup menu. The terminal window scrolls automatically when the cursor attempts to move below the bottom edge (for example, if you press RETURN when you are at the bottom of the window).

RealLink provides a range of font sizes, and also includes an auto-size option. With this selected, changing the size of the window automatically selects the largest font that will allow a full terminal page (see below) to be displayed. Once this has been done, the size of the terminal window is adjusted to display a full terminal page. Similarly, if you increase or decrease the size of the font, the size of the terminal window is adjusted to display a full terminal page.

The Terminal Page

The RealLink terminal page is the equivalent of the screen of a normal terminal. All output directed to the screen by an application goes to the RealLink terminal page, and any cursor positioning commands are relative to the top left-hand corner of this page. When you set up a RealLink configuration, you can specify the number of columns and lines available on the terminal page - the default is 80 columns by 24 lines.

Note that the terminal page is not the same as the terminal window. The terminal window can be changed in size and can be scrolled to display up to 255 history pages (refer to chapters 5 and 6). The terminal page becomes larger when you make the RealLink window larger, but it cannot be made smaller than the size set using the Setup Terminal Preferences command. If the RealLink window is reduced in size, or if the text font is made larger, only part of the terminal page can be displayed - this is normally the bottom part, though you can scroll to any part of the terminal page. If you minimise the window, or scroll to a history page, no part of the terminal page is displayed; however, screen output from an application is still printed to the terminal page, and can be displayed by restoring the window, or by returning to the current page, as appropriate.

System Messages

System messages received from the host will be displayed in the bottom line of the RealLink terminal window in the same way as on Northgate Prism P12 and P14 terminals.

The User Interface Management System

RealLink includes a User Interface Management System (UIMS) which provides a way for programmers to create applications on Reality which make use of the facilities provided by the Microsoft Windows graphical user interface. This software consists of the following components:

- An Application Programming Interface for DataBasic (DataBasic API). This provides the commands that programmers use to access the RealLink user interface when developing applications in DataBasic on a host system. In turn, RealLink provides access to the graphical user interface functionality of the Microsoft Windows environment.

- A resource compiler for use by application programmers. This allows the graphical objects used by an application to be defined on the PC rather than the host, thus improving performance by sharing the processing and reducing communication between the two systems. In addition, resources created in this way are loaded only when the application is run, allowing a programmer to produce different versions of an application, without having to change the host program.

There are three types of application program which make use of the UIMS DataBasic API: true UIMS applications; NewView applications and 'hybrid' applications.

- A UIMS application is one which uses only the advanced user-interface functions of the RealLink software for input and output.
- A NewView application is a character-display application whose presentation has been improved by the addition of some advanced user-interface functionality. The NewView features of UIMS allow existing applications to be converted with minimal changes to the original code.
- A hybrid application is also an improved character-display application. It uses more features of UIMS than are available in NewView, but still relies largely on standard character input and output for its user interface.

The User Interface Management System is described in detail in the UIMS manuals listed in the Related Documents section in Chapter 1.

Chapter 3

Installation

This chapter tells you how to install RealLink on your PC and how to configure Reality accounts to use the UIMS DataBasic API.

Introduction

The RealLink software is in three parts:

1. Windows software which must be installed on the PC or on a Network Server as described in the procedure on page 3-27. If you install the software on a Network Server, you can then set up individual workstations to use RealLink.
2. RealLink host software which provides the HOST-WS, WS-HOST, PASS-DOS and SPASS-DOS file transfer utilities (see Chapter 7). These are the only methods available for transferring Reality files via asynchronous links; they can, however, also be used over local area networks.
3. UIMS host software which allows you to run UIMS and NewView applications.

The RealLink and UIMS host software is supplied with Reality V9.0.

The steps that System Managers must carry out to configure accounts to use the RealLink and UIMS host software are described on page 3-33.

Installing the PC Software

Hardware and Software Requirements

To use RealLink, your PC must meet the following minimum requirements:

- A PC with Windows 7, XP, 2000, NT 4.0, ME or 98.

Note: RealLink can be used on 64-bit versions of Windows 7 Professional, Enterprise or Ultimate running in Windows XP mode. See [Installation on 64-bit versions of Windows 7](#) on page 27 for details.

- A CD ROM drive.

You will require at least 5Mb of free space on your hard disk.

Host Connection

Connection to a Northgate host may be via an asynchronous link or a local area network.

- Connection via asynchronous link can be local (direct connection), remote (via telephone links and modems) or via a suitable wide area network.
- The PC can be connected to a TCP/IP LAN.

Asynchronous Connection:

Host:

- Northgate UNIX system,
- or -
- Northgate SOVEREIGN system,

PC:

- At least one free serial port for connection to the host.

LAN Connection:

Host:

- Any host that supports a Telnet connection via a Local Area Network,
- or -
- A Northgate UNIX system running UNIX-Connect version 1.3 Rev F or later,
- or -
- A PC with Windows NT/2000 running Reality V9.0 or later.

PC:

- A suitable LAN card or dial-up connection.
- PC/ Standard Network Interface software.

Installation on a Network Server

You can install RealLink on a stand-alone PC or on a Network Server. If you are installing on a Network Server, you have two options:

1. You can perform a Server installation (when prompted, choose the Server option for your network) onto a shared network drive. Once you have done this, an installation program option allows you to set up networked Workstations to use RealLink (see page 3-29).

When using a Server installation option, you should note the following:

- If your users are running shared copy of Windows, the shared Windows directory must *not* be a root-mapped drive.
 - If your users are running shared copy of Windows, and you are upgrading a previous version of RealLink, all users must exit from Windows before you start the installation.
2. You can copy the contents of the RealLink CD to a network drive and perform a Local installation from there, instead of from the CD. If you have to install RealLink on a number of PCs, this can be quicker than installing from CD, and means that users at remote sites can install RealLink from the network.

Installation on 64-bit versions of Windows 7

RealLink can be used on 64-bit versions of Windows 7 Professional, Enterprise or Ultimate, but must be run in Windows XP mode. This must be installed as follows:

1. Check that your PC is able to run in XP mode by following the instructions at <http://www.microsoft.com/windows/virtual-pc/support/configure-bios.aspx>.
2. If you can run in XP mode, download and install Windows XP Mode and Windows Virtual PC.
3. Start the Windows XP Mode virtual machine by selecting **All Programs > Windows Virtual PC > Windows XP Mode** from the Start menu. Click the XP Mode Virtual Machine to select it.
4. Insert RealLink CD into your CD drive. From within Windows XP Mode, browse to the CD using Windows Explorer.
5. Run the program SETUP.EXE to install RealLink (follow the instructions in [Using the Setup Program](#) below, starting from step 3).
6. To make the WinSNI Configuration Editor available from the Windows 7 Start Menu, copy the shortcut C:\Documents and Settings\XPMUser\Start Menu\Programs\WINSNI Configuration Editor in Windows XP Mode to C:\Documents and Settings\All Users\Start Menu\Programs on Windows 7.

You will then be able to start both RealLink and the WinSNI Configuration Editor from either Windows 7 or Windows XP Mode. Note, however, that you can only start them from Windows 7 if Windows XP Mode is not running.

Using the Setup Program

The RealLink Setup program decompresses the RealLink program and other files and copies them to your hard disk.

The following procedure describes how to install RealLink.

1. Close any open applications.

Note: If you are installing RealLink on a Network Server, you must be running Windows from the server.

2. Insert RealLink CD into your CD drive. The installation program should start automatically; if it does not start, select **Run** from the Start menu and enter the following command:

drive:\SETUP

where *drive* is the letter of the drive containing the RealLink CD.

3. When Setup starts, follow the instructions on the screen. When prompted, select **RealLink & PCSNI Software** and then **Full Install**. When a welcome message appears, click **OK**.
4. You will then be asked the following:

- Whether you want to install RealLink on your PC (Local) or on a Network Server. If you are installing on a Network Server, refer to the notes on page 3-26.
- For the 24-character Software Key supplied with your RealLink software.

Note: Setup only asks you for the Software Key the first time you use your RealLink installation CD. If you have a multi-user licence and are installing on the second or subsequent PC, or if you are re-installing RealLink, you will see a copyright message.

- The name of your company. If you have a single-user licence, you will also be asked for your name.
- To select the files you want to install (local installation only). You can choose from the following:

Rfw The RealLink program.

Resource Compiler You will only require this if you intend developing UIMS applications.

Examples Example macros and DataBasic programs. See page 3-30 for details.

Wlanftu The LanFTU file transfer utility (see Chapter 7).

RPQs These provide the Terminal Executive facilities needed by certain applications. Your Northgate representative will tell you which, if any, of these you need.

Sovereign Extensions These provide additional facilities for use with Northgate Sovereign and SovereignX systems (you can only install these if you have purchased the appropriate software key).

Note: If you select this option when upgrading from an earlier version of RealLink, you will be prompted for your Sovereign Extensions software key.

- To choose a drive on which to install RealLink.

- For the name of a directory in which to install RealLink.

Note: If you are installing RealLink on a Network Server, this directory must be on a remote disk drive.

- Whether or not you want to overwrite your default configuration file (RFWDEF.CFG). If you have changed your default configuration, you should answer No. If you answer Yes, your old default configuration file will be renamed RFWDEF.OLD.
- Whether or not you want to overwrite the printer table files, RFWPRINT.XLT and SXPRINT.XLT (SovereignX extensions only). If you are using modified printer tables, you should answer No. If you answer Yes, your old printer table files will be renamed RFWPRINT.OLD and SXPRINT.OLD respectively.

When the installation is complete, the Program Manager will include a RealLink group, containing the RFW icon.

Installing RealLink on a Network Workstation

If you have installed RealLink on a Network Server, you will need to set up each workstation on which it will be used. This is done by running Setup from the RealLink program directory on the Server.

1. From the workstation to be set up, log on as a network supervisor.
2. Start Windows on the Network Server.
3. Start the Windows File Manager and select the RealLink program directory on the Network Server.
4. Select the file SETUP.EXE in this directory.
5. Select the Run command from the File directory. When the run dialog appears, press the END key, and type SPACE followed by "/n" (in lower case):

SETUP.EXE /n

Then click the OK button.

6. When Setup starts, follow the instructions on the screen. You will be asked the following:
 - To choose a *local* drive on which to install RealLink.
 - For the name of a directory in which to install RealLink's user files.

RealLink Files

When you run the RealLink Setup program, the RealLink files are installed in the directory you specify; the directory is created if it does not already exist. Two sub-directories are also created to hold the RealLink resource and help files.

In addition, two files are created in other directories. The RealLink initialisation file, RFW.INI is installed in your Windows program directory, and the font file appropriate to your display type (RFWEGA.FON or RFWVGA.FON) is installed in the Windows SYSTEM sub-directory.

Note: When you install RealLink on a network, the font file is installed on the workstation, not on the server.

Examples

If, when you install RealLink, you select the examples option, the following files are installed:

Macro Examples (user directory) -

APPLIC1.MAC
APPLIC2.MAC
EXAMPLE.MAC

Button bar bitmaps for macro examples (user directory) -

VCRBEGIN.BMP
VCREND.BMP
VCRFFWD.BMP
VCRFWD.BMP
VCRPAUSE.BMP
VCRPLAY.BMP
VCRREV.BMP
VCRSTOP.BMP

DDE Examples (EXAMPLES directory) -

RFW_DDE2.XLM Excel macro sheet.
RFWDDE.DOC Word for Windows 2.0/6.0 template.
RFWDDE95.DOC Word 95 template.

DataBasic Examples (EXAMPLES directory) -

These examples fall into two categories:

- DataBasic source code for UIMS subroutines. These are intended to show programmers how UIMS functions on the PC are called from a Reality host. The same method can be used on hosts that do not support DataBasic.

| | |
|----------|---|
| EXECUTE | The UIMS Execute subroutine. |
| GETRESP | Called by the Execute , SendKeys and SystemCommand subroutines. |
| ISUIMSC | The UIMS IsUimsCapable subroutine. |
| SENDKEYS | The UIMS SendKeys subroutine. |
| SYSTEMCO | The UIMS SystemCommand subroutine. |
| RFWDEFS | Constant definitions for Execute , IsUimsCapable and SystemCommand . |
| RFWKEYS | Constant definitions for SendKeys . |

- Examples that demonstrate the use of the **Execute**, **SendKeys** and **SystemCommand** subroutines:

| | |
|------------|---|
| SEARCH.WIN | Demonstrates Execute and SendKeys . |
| WEX | Demonstrates Execute . |
| WEXW | Demonstrates Execute . |
| WHAT.IS | Demonstrates SystemCommand . |

Configuring RealLink

The RFW.INI File

The RFW.INI created in your Windows program directory is used to store user-definable initialisation parameters. These are described in Appendix A.

Command Line Parameters

When you start RealLink, you can include various command line parameters and switches. These allow you to:

- Load a configuration file and automatically connect to the specified host.
- Prompt for a configuration file when RealLink starts.
- Set the number of history lines or pages, overriding the setting in any configuration file.
- Load a dynamic-link library to provide special functionality.
- Control whether or not the RealLink window appears (for use when debugging UIMS applications).
- Execute a macro when RealLink starts.

The complete syntax of the RFW command is as follows:

```
RFW {config-file} {/C} {/Ldll-name {...}} {/W1}{/Mmacro-file {...}}
```

The parameters and switches in the above have the following functions:

| | |
|----------------------|--|
| <i>config-file</i> | Is the name of a configuration file which will be loaded and used to make the initial connection. |
| /C | Specifies that the Connect dialog should be displayed when RealLink starts. |
| /L <i>dll-name</i> | Specifies that the dynamic-link library, <i>dll-name</i> , should be loaded. |
| /W1 | Specifies that the RealLink window is to remain visible when a UIMS application is started. This switch is for use when debugging UIMS applications. |
| /M <i>macro-file</i> | Specifies that the macro file, <i>macro-file</i> , should be loaded when RealLink is started. See Chapter 8 for more details. |

The command line parameters and switches can be entered in two ways:

By selecting the Run command from the Program Manager File menu and entering the RFW command followed by the required parameters

By changing the properties of the RFW icon. You can also take copies of the RFW icon and give each icon different properties.

SovereignX DLLs

The RealLink Sovereign extensions include dynamic-link libraries that change the keyboard mapping to emulate a SovereignX data entry keyboard. Each DLL has a name with the form:

KBDDE*Country*.DLL

where *Country* is the international dialling code for the country concerned. For example, the U.K. data entry DLL is called **KBDDE44.DLL**.

If you need to use SovereignX data entry, you should load the appropriate DLL when you start RealLink, by using the /L option as described above. For example, to load the U.K. data entry DLL, start RealLink as follows:

RFW /LKBDDE44.DLL

Host Software

The RealLink and UIMS host software must be installed by a Northgate service engineer. Once the software is installed, System Managers must configure their systems to allow users to access the software.

When the RealLink host software is installed, an account called REALLINK is created, containing the HOST-WS, WS-HOST, PASS-DOS and SPASS-DOS file transfer utilities. Similarly, when the UIMS host software is installed, a UIMS account is created, containing the catalogued subroutines for the DataBasic API. When the software is first installed, however, the utilities and subroutines respectively are available only from these accounts. Before you can use the file transfer utilities or UIMS applications from any other account, the account must be set up so that it has access to the appropriate software. You can add RealLink and UIMS to several accounts at once by using the SETUP-ACCOUNT command. Refer to the *Reality Reference Manual, Volume 3: Administration* for details.

Reality Item Size

By default, the largest item that can be created on the host with the WS-HOST command is approximately 30,000 bytes. If the data exceeds this maximum size, the excess data will be written to overflow items with an incrementing suffix of .0001, .0002 etc. appended to the item-id.

If you need to create items larger than 30,000 bytes with WS-HOST, you can configure RealLink to permit this.

Warning

The maximum item size must not be set to larger than 30,000 bytes on host systems with operating system releases prior to release 7.0.

The maximum item size is determined by the contents of attribute 51 of item RL.OPTIONS in the file RL.BP in the RealLink account. If this attribute does not exist, the maximum item size defaults to 30,000 bytes.

The user can reduce the set maximum item size by using a filter (refer to Appendix C for details).

Workspace Configuration

The larger the item, the longer Reality will require to create it. However, the time taken also depends on the maximum amount of workspace that is available and the size of the Workspace Increment. The larger these two parameters are, the quicker the item will be created.

Users who expect to regularly create items larger than 30,000 bytes should have a Security Profile which defines a Workspace Increment of 256 or larger and a Logon Workspace of a similar size. The Maximum Workspace Size should be as large as possible. Refer to the description of the SSM command in your Reality system documentation for details of how to set these parameters.

Chapter 4

Getting Started

This chapter shows you how to get started with RealLink once you have installed the PC software. It covers the basics of setting up an initial network or asynchronous session, and shows you how to start RealLink and how to close it down when you have finished.

Introduction

When you start RealLink or create a new configuration, a default configuration is selected. This is suitable for communication with all Reality systems and in most cases you will not need to change anything. However, successful communication between two computer systems depends on their both using the same communications parameter settings. If you experience any problems with an asynchronous session, you should check that the host and the PC are both using the same settings for the following:

- Baud rate
- Parity
- Data format (number of data bits)
- Number of stop bits
- Type of flow control

For asynchronous connections, your host system manager will tell you the current settings for the port you are using.

In addition, for both Network and asynchronous sessions, you should check that you are using the correct terminal emulation - the default is ANSI emulation. Note, however, that an incorrect setting may only give problems with some applications.

Refer to Chapter 6 for more information about these parameters. Chapter 5 describes in detail how to use RealLink, while Chapter 9 describes some common problems and suggests solutions.

Setting up a Session

To set up a session proceed as follows:

1. Start RealLink by double-clicking the RfW icon.



The title bar of the RealLink window appears as follows:



2. Pull down the Connection menu and select the Connect command. You will see a dialog box similar to the following:

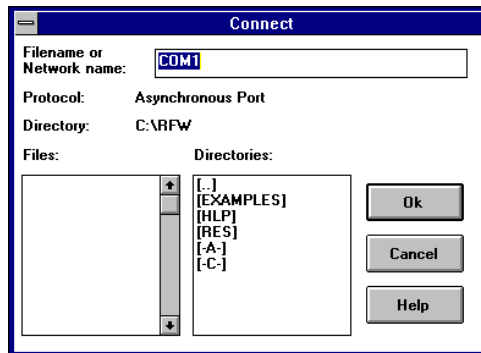

3. The default configuration selects asynchronous port COM1 - if you are using COM2, 3 or 4 enter this in the Filename or Network Name text box. For a network session, replace the port number with the network name of the host to which you intend connecting.

There are a number of parameters that you can set up, but this is sufficient to allow you to connect to your host.

Notes:

- Network connections are only available if RealLink is used in combination with the PCi Standard Network Interface.
 - For Network connections you will be able to connect to any host that can be resolved by TCP/IP, provided it supports the default protocol. The host does not have to appear in your SNI configuration file. Hosts that do not support the default protocol must, however, have an entry in the SNI configuration file - refer to the *PCi Standard Network Interface Installation Guide* for details.
4. Click the OK button to connect to your host system - the Logon prompt appears (for asynchronous sessions to Reality systems, you must press ENTER). You can now log on and use the system in the normal way.
 5. When you have finished using the host, log off in the normal way and then close RealLink by selecting Exit from the File menu. The following message appears:



Caution

You should never disconnect without first logging off from the host. In the case of an asynchronous connection, this will simply leave you logged on - you can reconnect at a later time and continue where you left off, though this is not recommended for reasons of security. In the case of a LAN connection, however, the host will be disconnected and any open files closed - this could result in loss of data.

Select OK to disconnect from the host, or Cancel to continue the current session.

6. You will now see the following dialog:

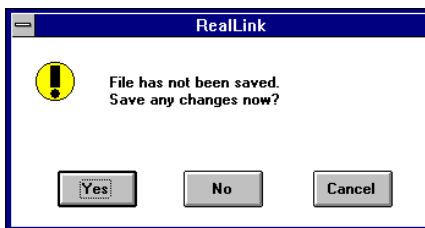

You must now decide whether to save the configuration information:

- If you intend connecting to the host regularly, or have changed any configuration parameters as described in Chapter 6, click Yes to save your configuration.
- If you do not want to keep the new configuration, click No.

You can return to RealLink by clicking Cancel. You will not lose your configuration information, but will need to use the Connect command to re-establish your connection.

7. If you answer Yes to the previous message, you will see the following dialog box:

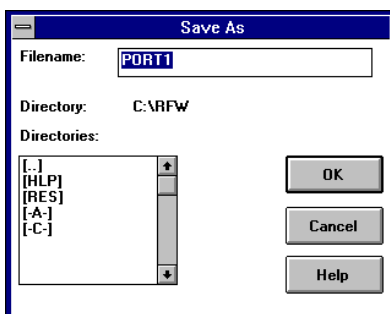

This allows you to choose a name for your configuration file - a name is suggested at the top of the dialog, but you can change this to any valid DOS filename. You are recommended to use the extension .CFG, so that the file will be listed in the

Connect and File Open dialog boxes. If you do not specify an extension, .CFG will be added automatically.

Next time you want to log on to this host, you can simply select the Connect command and then choose your CFG file from the list that appears.

Chapter 5

Using RealLink

This chapter describes how to start RealLink, connect to a host system and use the various features of the RealLink terminal emulator.

Starting RealLink

The normal method of starting RealLink is by double-clicking the RfW icon in the Program Manager.



Alternatively, you can use any of the other methods described in the *Microsoft Windows User Guide*. For example, if you regularly connect to one particular host, you could use the Properties command on the Program Manager File menu to add the name of a configuration file and any switches you need (see Chapter 3), so that you will be automatically connected to that host whenever you start RealLink. If you connect to more than one host, you can take one or more copies of the RealLink icon and set up each one to connect to a different host.

The RealLink window appears as shown in Figure 5-1.

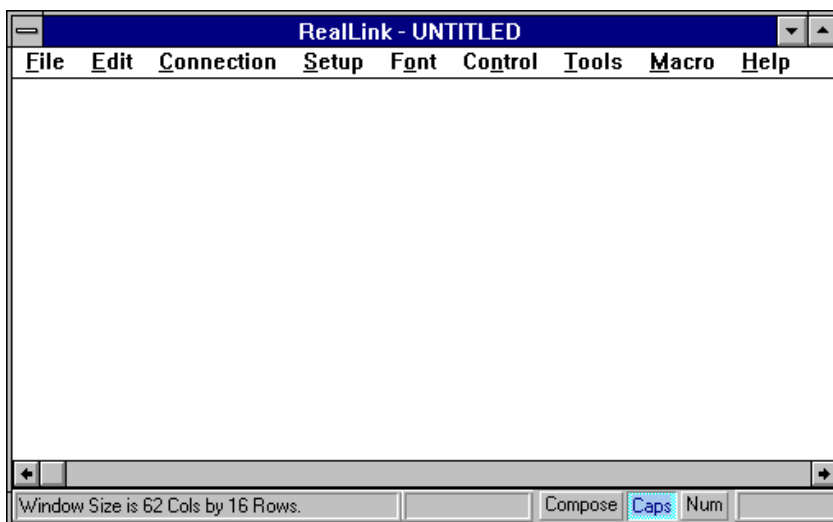





Figure 5-1. RealLink Application Window

The Status Bar

This is displayed at the bottom of the RealLink window as shown in Figure 5-1. It shows the following:

- A brief report on the current state of RealLink.
- A panel in which the following icons can appear:
 -  Pause is in effect (see page 5-50).
 -  The keyboard is locked.
 -  The Stream to File option is selected (see page 5-63).
- A Compose button. This allows you to enter diacritical characters. These are constructed by combining two other characters - for example, the character "ä" could be constructed by combining the letter "a" with a double-quote character (").

When selected, the Compose button is displayed in a different colour to the rest of the status bar.

- Caps and Num buttons. These have the same effect as the CAPS LOCK and NUM LOCK keys on the keyboard. When selected, they are displayed in a different colour to the rest of the status bar.

You can hide the Status bar, if required, by using the Status Bar command on the Setup menu.

Connecting to a Host

Once you have started RealLink, you can connect to a remote host. There are two ways of doing this:

- You can select the Connect command from the Connection menu. The dialog box shown in Figure 5-2 will appear.

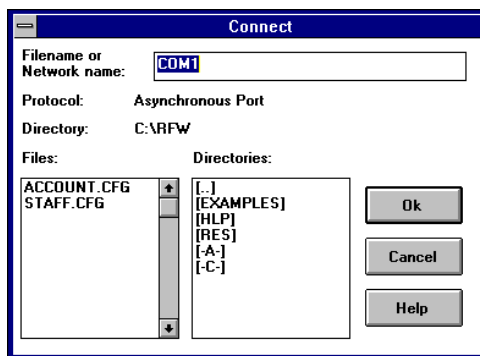

Figure 5-2. Connect Dialog

This command allows you to select a configuration file and then attempts to establish a connection using the information from this file. Note, however, that you do not need a configuration file to make a connection. If you enter the name of a host for which there is no configuration file, a new configuration will be created using the default settings stored in the file RFWDEF.CFG and a connection will be attempted. If you want to retain this new configuration for later use, you should save it before attempting a new connection or leaving RealLink. Chapter 6 describes how to save your configuration and how to change your default settings by modifying the RFWDEF.CFG file.

Note: If you start RealLink with the /C command line switch, the Connect dialog will be displayed automatically.

- You can start RealLink with the appropriate configuration file already loaded. This is done by including the name of the configuration file in the RFW command line. For example, the command

```
C:\RFW\RFW.EXE ACCOUNTS.CFG
```

starts RealLink with the file ACCOUNTS.CFG already loaded. Connection to the host system specified in this file will be established automatically, ready for you to log on.

If you regularly connect to a particular host system, you can use the Properties command on the Program Manager File menu to add the name of a configuration

file to the command line for your RFW icon. You can also create additional RFW icons and set up each for connection to a different host.

Note: There are various switches that you can use on the RFW command line, in addition to the name of a configuration file. These are summarised in Chapter 3 and described in detail with the features to which they relate.

Once the connection has been successfully made, you will be presented with the logon text and prompt produced by the host to which you are connected. You can now log on and run applications in the same way as you would from a normal terminal.

Network Connections

Network connections are only available if RealLink is used in combination with the PC*i* Standard Network Interface. If you attempt to start a Network session, but have not installed the PCSNI network interface software, you will see a warning message - refer to the *PCi Standard Network Interface Installation Guide* for details.

Using Multiple Connections

Although you can load only one configuration file into RealLink at a time, it is possible to connect to a second host (or to a second account on the same host) by starting a second instance of RealLink. The number of instances that you can use simultaneously depends on the amount of memory you have in your PC, and the other Windows applications that are running.

When you are using more than one instance of RealLink, the names of the configuration files for the different sessions will appear on the Connection menu. The sessions are numbered 1, 2, 3, etc. in the order in which they were started; the current session is not listed. You can quickly swap to another session by selecting the appropriately numbered command from the Connection menu.



ALT+1, ALT+2, etc.

The Connect New RfW command on the Connection menu will start a new instance of RealLink. The Connect dialog (see Figure 5-2) is displayed to allow you to enter a host name or choose a configuration file.

Terminating a Session

When you have finished working on the host system you should log off and disconnect by selecting the Disconnect command from the Connection menu. The following message will appear.



Caution

You should never disconnect without first logging off from the host. In the case of an asynchronous connection, this will simply leave you logged on - you can reconnect at a later time and continue where you left off, though this is not recommended for reasons of security. In the case of a LAN connection, however, the host will be disconnected and any open files closed - this could result in loss of data.

Select OK to disconnect from the host, or Cancel to continue the current session.

Note: You can have only one configuration file loaded at a time. If you attempt to start a new session without first disconnecting, the message shown above will appear. Select OK to disconnect from the current host and start a new session, or Cancel to continue the current session.

Closing RealLink

You close RealLink in the same way as any other Windows application:

- By selecting Exit from the File menu.
- By selecting Close from the System menu



Double-click the System menu box.

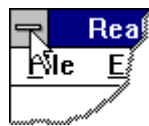

Press ALT+X.

Note: You cannot close RealLink by pressing ALT+F4, since this key combination is used by the terminal emulator.

If you have an open connection, you will be asked if you want to disconnect. Similarly, if you have changed the configuration in any way and have not saved the configuration file, you will be asked if you want to save your changes.

Using the Mouse and the Keyboard

In common with other Windows applications, RealLink can be controlled using both a mouse and the keyboard. You can select menus and commands in the same way as you would in any other Windows application and, once you have connected to a host, you can use the keyboard in the same way as on a normal terminal. The cursor appears as a flashing underline, a vertical bar, or a solid block, depending on the setting chosen in the Terminal Preferences dialog.

Editing Functions

In addition to the normal terminal functions, RealLink allows you to select text displayed in the terminal window, copy it to the Windows clipboard and paste it back into RealLink or into any other Windows application. Similarly, you can paste text from the clipboard into RealLink.

There are many uses for the RealLink editing functions. The following list gives just a few suggestions:

- You can repeat previously executed commands by copying them from the screen and pasting them back into RealLink.
- You can prepare complex commands in a text editor such as Notepad, and then transfer them to RealLink via the clipboard.
- You can copy the output of an English command into a report or other document which is being prepared with Windows Write or some other word processor.

Selecting Text

You can select text in the terminal window with either the mouse or the keyboard. Selection with the mouse is the same as in any other Windows application - point to the start of the required text, hold down the left mouse button, and drag the mouse to the end of the text. To select text with the keyboard, however, you must change RealLink into selection mode, as follows:

1. Press the Mode key to set the keyboard into selection mode. The Mode key is normally SCROLL LOCK, but is defined in the RFW.INI file and can therefore be changed if required (for details, see Appendix A).
2. Move the cursor to the start or end of the section of text that you want to select.
3. Hold down the SHIFT key and move the cursor to the opposite end of the text section.
4. Release the SHIFT key.
5. Press the Mode key again to return the keyboard to its normal mode of operation.



While in selection mode you can use the following keys to move the selection cursor and select text:

- The up, down, left and right cursor keys.
- HOME moves the cursor to the start of the current line. If the cursor is already at the start of a line, HOME moves the cursor to the top of the RealLink window.

- END moves the cursor to the end of the current line. If the cursor is already at the end of a line, END moves the cursor to the end of the last line in the RealLink window.
- PAGE UP moves the cursor to the previous page.
- PAGE DOWN moves the cursor to the next page.
- CTRL+HOME moves the cursor to the start of the oldest history line.
- CTRL+END moves the cursor to the end (column 80 or 132) of the last line of the current terminal page.

Whether you use the mouse or the keyboard, text which is selected is shown highlighted; that is, shown in white letters against a dark background, or in dark letters against a coloured background. How selected text appears depends on your screen colours.

Note: While you are selecting text, the terminal emulator window will scroll if the pointer or cursor is taken beyond the edge of the window.

Column Selection

The method described above selects text line by line. For example, if you position the cursor in the middle of a line, then hold down SHIFT and move the cursor down one line, the text from the original cursor position to the end of that line will be selected, plus that from the start of the next line to the new cursor position. There are, however, occasions when you want to select a column of text from the middle of the display. RealLink provides a column selection mode which allows you to do this.

You place RealLink into column selection mode by holding down the ALT key as you start to make your selection. For example, to select a column of text with the mouse, hold down the ALT key before starting to drag the mouse pointer. Once you have started dragging you can release the ALT key.

Copying your Selection to the Clipboard

Once you have made your selection, you can use the Copy or Append command on the Edit menu to copy the text onto the clipboard.

- Copy replaces the current contents of the clipboard with the selected text.



CTRL+INSERT

- If there is already text on the clipboard, Append adds the selected text to the end. If, however, the clipboard contains data in another format (a bitmap, for instance), Append is not available.



ALT+INSERT

Note: You can also use the advanced editing functions described on pages 5-45 to 5-48.

Once on the clipboard, the text can be pasted back into RealLink or into other Windows applications.

When copying text to the clipboard there are a number of points of which you should be aware:

- The Strip Spaces command on the Edit menu allows you to choose whether or not trailing spaces at the ends of lines are deleted. This applies to both normal (line) and column selection modes.
- A selection that extends for more than one line will have a carriage return character added to the end of each line. Similarly, if a selection ends in the left-hand margin, it will be terminated with a carriage return.
- Only standard characters can be copied. Special characters, such as line drawing or video attribute characters, will be converted to spaces.
- Text which is displayed with the Blank screen attribute will be converted to spaces.

Paste

This command copies text from the clipboard to the current cursor position. Each character is sent to the host system as though it was typed from your PC keyboard. Previously entered host commands can be copied and re-entered using Paste. The text on the clipboard can be text that has been copied within RealLink or from another Windows application. If there is no text-format data on the clipboard, this command will not be available.



SHIFT+INSERT

Advanced Editing Functions

In addition to the simple Copy and Paste commands described above, you can use the advanced editing functions described below.

Copy Window

If the text you wish to copy occupies the complete RealLink window, you can use the Edit Copy Window command. This copies all the text you can currently see in the RealLink window to the clipboard. There is no need to select the text you require before using this command.

Copying Tables

The Copy Table command on the Edit menu allows you to copy text that is formatted as a table on the RealLink screen to the clipboard in a format suitable for pasting into other Windows applications. The text is converted as specified by the Configure Table command.

The Configure Table command on the Edit menu allows you to specify a format for tables copied from the RealLink window to the clipboard. When you select this command, the dialog box shown in Figure 5-3 appears.

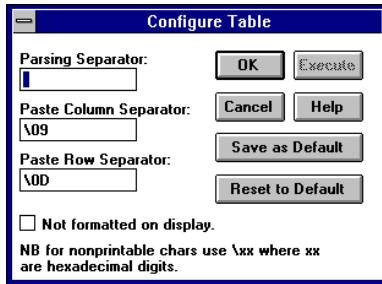

Figure 5-3. Configure Table Dialog

This dialog has the following options:

Parsing Separator Enter the character or characters that separate the columns of the table on the screen.

Note: To specify a control or non-printable character, enter a backslash, followed by two upper case hexadecimal digits representing the ASCII code for the character. For example:

| | |
|-----------------|-----|
| Tab | \09 |
| Carriage return | \0D |
| Line feed | \0A |
| Backslash | \5C |

When the text is copied to the clipboard, leading and trailing occurrences of the Parsing Separator will be ignored.

Paste Column Separator

Enter the character or characters that will separate the columns of the table when they are copied to the clipboard.

Paste Row Separator

Enter the character or characters that will separate the rows of the table when they are copied to the clipboard.

Not formatted on display

If this option is not selected, the table to be copied is assumed to be displayed as a table in the RealLink window. Consecutive multiple Parsing Separators on the screen will be converted to a single Paste Column Separator on the clipboard.

With this option selected, each occurrence of the Parsing Separator will be converted to a Paste Column Separator.

For example, if the Parsing Separator is set to an asterisk (*) and the Paste Column Separator to a caret (^), with Not formatted on display not selected, the following table on the screen:

```
22***RealLink
```

will be copied to the clipboard as:

```
22^RealLink
```

However, with Not formatted on display selected, each asterisk will become a caret:

22^^^Rea1Link

| | |
|------------------|---|
| Save as Default | If you use a particular combination of the above table options, you can save it as your default configuration by clicking this button. |
| Reset to Default | If you have changed the table options and want to return to your default settings, click this button. If you hold down the CTRL key while clicking this button, the table options are returned to the RealLink default settings. |
| Execute | This button allows you to copy the currently selected text to the clipboard without having to return to RealLink. |

Copying the Position of the Cursor

The Copy Coordinates command on the Edit menu allows you to copy the position of the currently selected text to the clipboard. If no text is selected, the command is disabled.

Similarly, the Append Coordinates command allows you to append the position of the currently selected text to the contents of the clipboard. If no text is selected, or the clipboard is empty, Append Coordinates is disabled.

These commands are useful when writing DDE commands in other applications, or creating hot spots in UIMS NewView applications. Note that vertical positions are specified as the number of characters from the top edge of the RealLink window, and horizontal positions as the number of characters from the left-hand edge; the top left-hand corner of the window is position 0, 0.

In both cases, the format used for the coordinates is as specified using the Set Coord. Format command. When you select this command, the dialog box shown in Figure 5-4 appears.

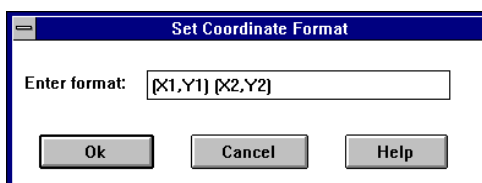

Figure 5-4. Set Coordinate Format Dialog

Enter the format you require, using the following to represent the start and end positions:

- X1 Will be replaced by the number of the column containing the start of the selected text.
- X2 Will be replaced by the number of the row containing the start of the selected text.
- Y1 Will be replaced by the number of the column containing the end of the selected text.

Y2 Will be replaced by the number of the row containing the end of the selected text.

All other characters will be copied to the clipboard unchanged.

The default format is:

(StartColumn,StartRow) (EndColumn,EndRow)

For Example, if the format “(X1,Y1) (X2,Y2)” is specified, and text is selected starting at column 10, row 5 and ending in column 35, row 9, when the Copy Coordinates command is used, the following will be placed on the clipboard:

(10,5) (35,9)

Mouse Shortcuts

You can carry out the following operations using the mouse:



You can select a complete word (delimited by spaces) by double-clicking the left mouse button.



If you select some text in the ReaLink window and click the right mouse button, the selected text will be copied to the current cursor position.



If do not have any text selected, you can point to, or to the left of, a word in the terminal window and click the right mouse button - the complete word will be copied to the current cursor position with a terminating carriage return. Note that in this case, a word can consist of only alphanumeric characters and hyphens.

The last two operations can be useful for repeating commands, and for selecting items from a menu or list of options.

If you hold down the ALT key and then click the right mouse button, the text cursor is moved to the same line as the mouse pointer and then the code for the F6 function key is sent to the application (as if this key had been pressed).

Function Keys

Some PCs have only ten function keys (F1 to F10), compared with the eighteen on the Prism terminal. In ReaLink, operations assigned to function keys F11 to F18 are obtained by combining the ALT key with keys F1 to F8. The available combinations are summarised in Table 5-1.

Table 5-1. Function Keys

| Prism | ReaLink |
|-----------------------|-----------------------|
| F1 to F10 | F1 to F10 |
| F11 to F20 | ALT+F1 to ALT+F10 |
| SHIFT+F1 to SHIFT+F10 | SHIFT+F1 to SHIFT+F10 |

| | |
|----------------------------------|--|
| SHIFT+F11 to SHIFT+F20 | ALT+SHIFT+F1 to ALT+SHIFT+F10 |
| CTRL+F1 to CTRL+F10 | CTRL+F1 to CTRL+F10 -or- CTRL+SHIFT+F1 to CTRL+SHIFT+F10 |
| CTRL+F11 to CTRL+F14 | ALT+CTRL+F1 to ALT+CTRL+F4 -or- ALT+CTRL+SHIFT+F1 to ALT+CTRL+SHIFT+F4 |
| CTRL+SHIFT+F1 to CTRL+SHIFT+F10 | CTRL+F1 to CTRL+F10 -or- CTRL+SHIFT+F1 to CTRL+SHIFT+F10 |
| CTRL+SHIFT+F11 to CTRL+SHIFT+F14 | ALT+CTRL+F1 to ALT+CTRL+F4 -or- ALT+CTRL+SHIFT+F1 to ALT+CTRL+SHIFT+F4 |

Notes:

- The Windows functions assigned to these key combinations are not available in RealLink. For example, you cannot close RealLink by pressing ALT+F4, nor can you obtain help by pressing F1 (refer to the appropriate sections of this chapter for alternatives).
- Function keys F19 and F20 are included for compatibility with the Northgate P30 terminal.
- If you are running RealLink on Windows 95, the key combinations ALT+F6 and ALT+SHIFT+F6 are not available. To obtain the P12 combinations F16 and SHIFT+F16, select Compose (see page 5-50) and then press F16 or SHIFT+F16 are appropriate.
- CTRL+F15 to CTRL+F20 and CTRL+SHIFT+F15 to CTRL+SHIFT+F20 cannot be used on RealLink.

History Pages

RealLink automatically retains information that has scrolled out of its terminal window. The number of lines retained is set with the Terminal Preferences command on the Setup menu: the default is 168; the maximum 6120.

As an alternative to the number of history lines, you can specify the number of history pages to be retained. Note, however, that the history page size depends on both the number of columns and the number of lines specified in the configuration.



The following keys allow you to view the history pages:

- | | |
|---------------|--|
| PAGE UP | Displays the previous (next older) history page. |
| ALT+PAGE UP | Scrolls the display up one line. |
| PAGE DOWN | Displays the next (more recent) history page. |
| ALT+PAGE DOWN | Scrolls the display down one line. |

ALT+END Displays the current page.

ALT+HOME Displays the oldest history page.

Note: These keys can only be used to access history pages when the keyboard is not in selection mode. The keyboard mode is set using the Mode key (see page 5-43).



If the vertical scroll bar is enabled, you can also use the mouse to access the history pages.

The Pause Key

The PAUSE key has the same function as the HOLD key on a Prism terminal. It prevents the screen display changing until PAUSE is pressed a second time. While pause is in effect, an icon is displayed in the status bar, together with the message "Press 'Pause' again to continue".

Entering Diacritical Characters

The Prism terminal has a COMPOSE CHARACTER key that allows you to enter diacritical characters - characters that are constructed by combining two other characters. For example, you could construct the character "ä" by pressing COMPOSE CHARACTER, followed by the letter "a" and the double-quote character (").

In RealLink you can produce the same effect by using either the Compose button on the status bar, or the right-hand ALT key (labelled ALT GR on most PC keyboards).

The Command Line Editor

There are many occasions when you will want to repeat a previous host command, or use a command that is similar to one you have just used. Reallink includes a command line editor which allows you to select a previous command and change it as required before execution.

To use the command line editor, select the Line Edit command from the Edit menu, or press CTRL+RETURN. You will see a dialog box similar to that shown in Figure 5-5.

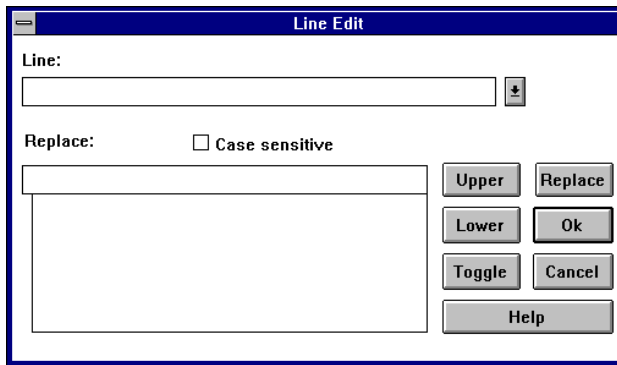

Figure 5-5. Command Line Editor

Repeating your Last Command

The Line edit box at the top of the dialog will contain the last command you entered. To repeat this command, simply click the OK button.

Repeating a Previous Command

If you click the down-arrow in the box to the right of the Line edit box, or press ALT+DOWN ARROW, a list of the previous commands you have used will be displayed. For example:

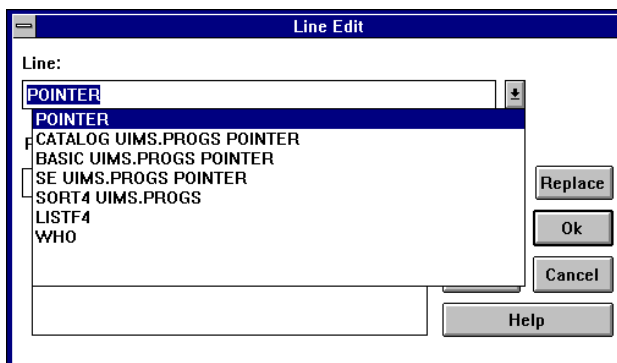

Use the UP and DOWN cursor keys to select a command and then click OK to execute it.

Notes:

- If you press CTRL+SHIFT+RETURN to display the Line Edit dialog, instead of CTRL+RETURN, the list of previously used commands will be displayed, ready for you to select a command.
- The list box normally displays the last 20 commands used. If you need more than this, you can set a larger number in the RFW.INI file. See Appendix A for details.

- You can prevent commands being added to the list by using the Command Stack command on the System menu of the dialog box. When this command is selected (marked with a tick), each command used is added to the list of previously used commands. If it is not selected, the existing list remains available, but new commands are not added to the list.
- For security reasons, passwords are not added to the command stack.

Changing a Command

If you wish, you can edit the selected command to produce a new command. The command line editor provides the following editing facilities:

- You can use the LEFT and RIGHT cursor keys and the HOME and END keys to move to any position in the line. Combining the cursor keys with the CTRL key allows you to move the cursor one word at a time, instead of one character at a time.
- You can select text by combining the SHIFT key with the cursor movement keys.

Note: Refer to the *Microsoft Windows User Guide* for more details of how to move the cursor and select text.

- You can use the Windows clipboard to cut and paste text. Use SHIFT+DELETE to cut, CTRL+INSERT to copy and SHIFT+INSERT to paste.

Note: Refer to the *Microsoft Windows User Guide* for more details of how to use the clipboard.

- You can change the case of the selected text. Click the Upper button to change it to upper case, and the Lower button to change it to lower case. The Toggle button changes all upper case characters to lower case, and all lower case characters to upper case.

Note: If there is no text selected, the case of entire line will be changed.

- You can replace specified text wherever it occurs in the command line (see below).

Selecting Text to Edit

If you wish, you can select text to edit from the RealLink window. Either select the text you require as described on page 5-43, or point to a line of text with the mouse. Then hold down the CTRL key and click the left mouse button. The Line Edit dialog will be displayed with the selected text in the Line box, ready for editing. If you did not have any text selected, the complete line of text pointed to by the mouse is copied into the Line box.

Pre-loaded Commands

If there are a small number of commands that you use very frequently, you can pre-load those commands into the list of previously used commands in the Line Edit dialog box. You do this by adding the commands to the [SaveCmds] section of the RFW.INI file (see Appendix A for details). The pre-loaded commands will always appear at the top of the list, before any previously used commands.

Note: Each pre-loaded command you add reduces the number of previously used commands available to you. You may need to increase the number of

commands retained by changing the MaxHist parameter in the [Editline] section of RFW.INI.

Using Replace to Edit Commands

The Line Edit dialog also includes a Replace feature that allows you to find text in your command line, and replace it with something different. To use this feature, do the following:

1. Select the command you wish to edit.
2. Select the part of the command that you want to search. If you do not make a selection, RealLink searches the entire command.
3. In the Replace text box, type the text to be replaced.

Tip: Use the clipboard to copy text from the old command into the Replace text box (see above).

4. If required, select the Case Sensitive option. Select this option to find only those occurrences with the combination of uppercase and lowercase letters you have specified.
5. Click the Replace button. You will see a dialog box similar to the following:

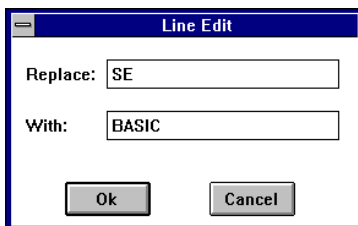

6. Type the replacement text in the With: box.
7. Click OK. If, in the Line text box, the cursor is an insertion point, the first occurrence of the search text, starting from the beginning of the command line, will be replaced. If any part of the command line is selected, the first occurrence of the search text within the selected text will be replaced.

Note: Instead of using the Replace dialog, you can enter the text to find, followed by the characters "->" and the replacement text. (If you wish you can redefine the Replace separator characters by changing the RepStr entry in the [EditLine] section of RFW.INI - see Appendix A for details.)

Repeating a Replace Operation

Each time you use Replace, your search and replacement strings are added to the list below the Replace text box. You can repeat a Replace operation by simply selecting it from the list box and clicking Replace. The list box normally displays the last 20 commands used; if you need more than this, you can set a larger number in the RFW.INI file (see Appendix A).

In the list box, the search and replacement strings are separated by the characters "->". You can change this if required in the RFW.INI file.

Pre-loaded Replace Strings

If you frequently make the same changes when editing host commands, you can pre-load the necessary replace commands into the list of previously used Replace operations in the Line Edit dialog box. You do this by adding the replace commands to the [SaveReps] section of the RFW.INI file (see Appendix A for details). The pre-loaded commands will always appear at the top of the list, before any previously used commands.

Note: Each pre-loaded replace command you add, reduces the number of previously used commands available to you. You may need to increase the number of commands retained by changing the MaxRep parameter in the [Editline] section of RFW.INI.

Obtaining Help

While you are using RealLink, you will often want to get help quickly as you work. You can do this by using the Help menu, or by pressing the Help key. When the Help window appears you can display the procedure for a task, get a definition for a term you don't understand, or see information about any RealLink command.

The Windows Help system is described fully in the *Microsoft Windows User's Guide*. This section describes the features that are specific to RealLink.

Help Menu

This menu contains commands that allow you to obtain help information about a number of RealLink topics or information about the application itself. The following commands are available from this menu:

| | |
|---------------|---|
| Index | This command lists the topics covered by the Help feature. From this list you can select the feature on which you need help. |
| Keyboard | This lists the available keyboard commands and gives information about the use of the keyboard. |
| Commands | This command lists the commands available from the RealLink menus. From this list you can select the command with which you need help. |
| File Transfer | This gives details of the different ways in which you can transfer files between your PC and the host. |
| Application | This command allows you to display help on a particular application. When you first install RealLink it will be disabled, but it can be enabled by setting the Help parameter in the [RealLink] section of the RFW.INI file (see Appendix A). |

The RFW.INI Help parameter must specify the name of a Help application. RealLink includes an example Help application - RFWHELP - which uses Windows Help to display a help file. This application provides the following options for viewing help:

- Any text selected when you choose the Help Application command is used as a "topic key-word". If the help file contains a topic with that key-word, the topic will be displayed; otherwise, you will see a message saying that an invalid key-word has been specified, and the contents topic will be displayed instead.
- If you have no text selected when you select the Application command, the contents topic of the specified help file will be displayed.

Appendix E gives guidelines for creating your own Help applications and Windows Help files.

| | |
|-------|--|
| About | This command displays a message box containing the version and revision of the software and its date of issue. |
|-------|--|

Context-sensitive Help

When you are using RealLink you may find that you need help, but cannot pull down the Help menu without first cancelling your current task. Under these circumstances, you can simply press the Help key to obtain help on the RealLink feature that you are currently using.

In most Windows applications, the Help key is function key F1. In RealLink, however, F1 is used by the terminal emulator. Instead, the Help key is normally CTRL+?, but can be redefined if required in the RFW.INI file - refer to Appendix A for details.

Note: On some keyboards you hold down the SHIFT key to obtain a question mark. If this is the case on your keyboard, you must press CTRL+SHIFT+? to obtain context-sensitive help.

To make it easy to obtain help, every RealLink dialog includes a Help button. Click this to display help specific to the current dialog.

Reality Help

The file QRG nn .HLP, supplied with RealLink, provides help on Reality. You can display the information in this file by using the Application help command described above.

Note: The help file might not cover your version of Reality.

To make Reality help available, add the following line to the [RealLink] section of your RFW.INI file:

```
Help=C:\RFW\RFWHELP.EXE C:\RFW\HLP\QRG $nn$ .HLP
```

If necessary, substitute the correct drives and paths for the files RFWHELP.EXE and QRG nn .HLP. Also, you must substitute the correct version number for the letters nn in QRG nn .HLP; use the File Manager to see which version of the file you have.

Running Applications

Once you have connected to a remote host system, you can use RealLink in much the same way as a normal terminal. Unlike a normal terminal, however, RealLink allows you to run both ordinary applications and utilities, and applications which are specially written to take advantage of the Windows environment. The latter, though running on the host, use a User Interface Management System (UIMS) on the PC to generate a graphical user interface similar to that used by normal Windows applications.

An ordinary application is run within the RealLink terminal emulator window, appearing in the same way as it would on a normal terminal. The RealLink menu bar remains displayed and most of its commands can be used.

A UIMS application is run in its own application window. When an application of this type is run, the RealLink window is made invisible and a new window is created. However, RealLink remains active. It monitors information that is received from the remote host and performs a window-management function. The menu bar and commands available in your application's window are determined by the application which you run. When you leave your UIMS application, its application window is closed and you are returned to the RealLink window.

Controlling UIMS Applications

While you are using a UIMS application, you may need to return to the RealLink window. In normal use, you will only need to do this if your application stops working, but if you are developing or supporting UIMS applications, you will need access to the DataBasic debugger.

You can return to the RealLink window from a UIMS application by pressing the Restore key. This key is defined by using the Restore Key command on the RealLink Control menu - the default setting is to use the CTRL+BREAK key combination. Refer to the next section for details of how to change the Restore key.

Once you have returned to the RealLink window, you can enter the DataBasic debugger, terminate the application, or return to your application and continue from where you left off:

- If the application is written in DataBasic and you want to debug it, you should press the Restore key a second time. The DataBasic debugger prompt will appear, allowing you enter debug commands.
- To terminate the application, first destroy the application's window by selecting the Clean-up command from the Control menu. Then press the Restore key a second time. If the application is written in DataBasic, you will enter the debugger at this point and must enter the END command to terminate the application.
- If you want to return to the application, use the Control Resume command. The dialog box shown in Figure 5-6 will appear.

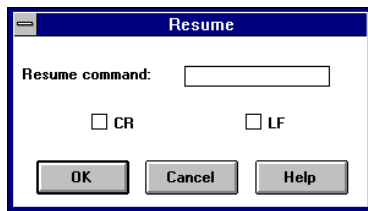

Figure 5-6. Resume Dialog

Clicking OK makes the ReaLink window invisible again and switches back to the current application. However, the dialog also allows you to enter a command and a command terminator for execution on the host. For instance, if you have been using the DataBasic debugger, you should use the G (GO) command terminated by CR (carriage return) to restart the application in its own window.

Note that when you use the Resume command, any command and command terminator you enter will be retained for use next time. Always check that you have the correct command and terminator before clicking OK.

Setting the Restore Key

The default Restore key is CTRL+BREAK, but if you wish, you can change it by using the Restore Key command on the Control menu. You can also change the code generated by the Restore key by using the Send Restore Key As command. The settings are saved in the configuration file.

When you select the Restore command, the dialog shown in Figure 5-7 appears:

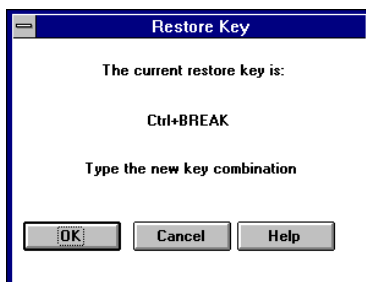

Figure 5-7. Restore Key Dialog

This dialog displays the current Restore key. This will be the default key combination, CTRL+BREAK, unless this has already been changed for the current configuration. To change the selection, press the key or key combination that you want to use - provided this is a valid key combination, it will be displayed in the dialog. There are some combinations, however, which cannot be used; if you choose one of these, the combination displayed will remain unchanged.

Note: In addition to its use within UIMS applications, the Restore key can be used in the ReaLink window to send a break to the host.

When used in the ReaLink window, the Restore Key sends a break to the host. However, with some types of connection (for example, when connected via Telnet), you will find that break has no effect. In this case, you can change the code generated by the Restore key to that defined in the REALBREAK environment variable on the host.

The Send Restore Key As command on the Control menu allows you to change the code generated by the Restore Key. When you select this command, the dialog shown in Figure 5-8 appears:



Figure 5-8. Send Restore Key As Dialog

This dialog displays the code that is currently generated by the Restore key. To change the selection, press the key or key combination that you want to use - provided this is a valid key combination, it will be displayed in the dialog. There are some combinations, however, which cannot be used; if you choose one of these, the combination displayed will remain unchanged.

Notes:

- If REALBREAK is not defined on the host, set the Restore key to send CTRL+C.
- To restore the default setting, press CTRL+BREAK.

Resetting the Terminal Emulator

If necessary, you can reset the RealLink terminal emulator by selecting the Terminal Reset command from the Control menu. You will see the following message:



Click the OK button to reset the terminal emulator and reload the settings stored in the configuration file.

This command should not normally be used while running applications.

Printing

There are many occasions when you might wish to obtain a printout of data received from the host, or displayed on the screen. ReaLink provides various ways of doing this:

- | | |
|------------------|--|
| Print Window | This allows you to print a copy of the contents of the ReaLink window. |
| Print Selection | This allows you to print text you have selected with the mouse or the keyboard. |
| Direct Printing | This allows a host application to print to a local printer. |
| Spooled Printing | This allows the entire contents of a host spooler queue to be output to a local printer. |

In all cases, print output is directed to the currently selected Windows printer. If you want to print to a file, you can use the Control Panel to direct the printout to the FILE: device.

Note that in all cases, while printing is in progress a dialog box similar to the following is displayed:



While this is displayed, you cannot use ReaLink, except to cancel the printout by clicking the Cancel button, or by pressing RETURN or ESC.

Printer Setup

The Printer Setup command on the File menu allows you to select a printer, and to decide whether you will use emulation or pass-through mode for direct printing. When you select the Printer Setup command, you will see a dialog box similar to the following:

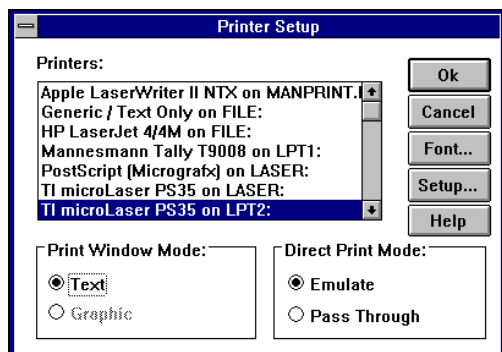

- The Printers list box allows you to select a printer from those you have set up in the Control Panel. The currently selected printer is highlighted. Note that if you do not select a printer, output is directed to the current default Windows printer.

- The Setup button allows you to change the configuration of the selected printer. Because different printers have different capabilities, the dialog box that appears depends on the type of printer that is selected. Refer to your *Microsoft Windows User's Guide* for more information on setting printer options.
- The Direct Print Mode buttons allow you to select whether the print data from the host will be passed directly to the printer driver (Pass-through), or whether Reallink will control basic cursor positioning (Emulate). The advantages and disadvantages of these modes are listed in Table 5-2. Note that Emulate mode is recommended for general use.

Table 5-2. Direct Print Modes

| Mode | Advantages | Disadvantages |
|--------------|--|--|
| Emulate | Guaranteed to print successfully | Control characters other than carriage return, line feed, form feed and backspace will be printed literally, with the result that the printed output may be incorrectly formatted and may contain some incorrect characters. |
| Pass-through | Printed output will always be correctly formatted. | Not all Windows printer drivers support Pass-through printing. If the selected printer driver does not support this mode, a message will be displayed on attempting to print. |

Note: When printing in Pass-through mode, the print progress dialog is unable to show the number of the page that is being printed. "Page 1" remains displayed throughout the print operation.

- The Print Window Mode options are provided for future enhancement. The Graphic option is not available on this version of Reallink.
- The Font button allows you to choose the font used for your printout. When you click the button, you will see a dialog similar to that shown in Figure 5-9.

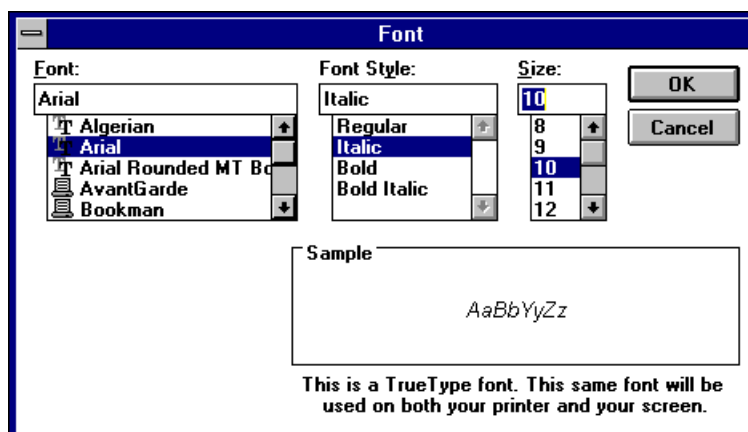

Figure 5-9. Printer Font Dialog

Choose a font, a style and a point size from the lists. Your selection will be saved in the RFW.INI file (see Appendix A) and used whenever you print.

Notes:

- If there no entry in RFW.INI, the selected printer's default font will be used.
- If you change to a printer that does not have the selected font, a message will be displayed to warn you that the selected font is not available; the selected printer's default font will then be used.

Print Window

To print all the text you can currently see in the RealLink window, select the Print Window command from the File menu. The text is printed using the default font for the currently selected Windows printer. Note that there is no need to select the text you require before using this command.

Note: The Print Window command on the menu is followed by the word 'text' in brackets. This indicates that the window will be printed in text mode. The alternative, graphics mode, is not available on this version of RealLink.

Print Selection

If you have selected some text with the mouse or the keyboard (as described on pages 5-43 and 5-44), you can print it by selecting the Print Selection command from the File menu. The text is printed using the default font for the currently selected Windows printer. If there is no text selected, this command is disabled.

Note: Printing always starts at the left-hand margin of the paper. If your selection starts in the middle of a line of text, this line will be shifted to the left when printed.

Direct Printing

Direct printing must be initiated by your host application. The application uses the printer as the output device in place of the screen.

Note: The Printer Setup command on the File menu allows you to select whether the print data from the host will be passed directly to the printer driver, or whether RealLink will control basic cursor positioning. Refer to page 5-60 for more details.

Spooled Printing

Spooled printing is initiated from the host system by using the PORT-DESPOOL TCL command. Refer to your Reality system manuals for details.

The Printer Setup command on the File menu allows you to select whether the print data from the host will be passed directly to the printer driver, or whether RealLink will format the print data.

Note: The 'X' option is recommended when using a shared network printer.

Printing to a File

Under some circumstances, you might need to print to a file rather than to a printer. There are several ways in which you can do this:

- You can use the Control Panel to connect your printer to the Windows FILE: device.

- You can specify a file to which to print in the WIN.INI file and use the Control Panel to connect your printer to this.
- You can use the RealLink Stream to File command as described below.

Streaming to a File

The Stream To File command on the Tools menu allows you to obtain a record of all text displayed in the RealLink window. When selected, all text subsequently displayed is also sent to a specified file.

When this option is selected, a tick is displayed next to the command on the Tools menu and an icon appears in the status bar. If the command is not already ticked when you select it, the dialog box shown in Figure 5-10 is displayed.

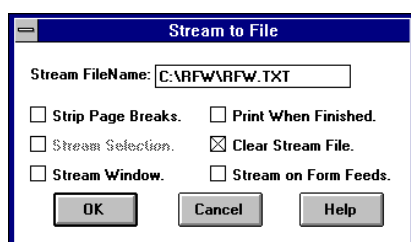

Figure 5-10. Stream to File Dialog

This dialog has the following options:

Stream File Name Type the name of the file to which screen output will be sent. If no path is specified, the file will be created in your RealLink user directory.

Strip Page Breaks When selected, this removes any form feed characters from the streamed output.

Stream Selection When selected, this sends the selected text to the file. It is only enabled when text is selected.

Stream Window When selected, this sends the contents of the RealLink window to the file.

Print when finished
If selected, this causes the contents of the stream file to be printed when streaming is turned off.

Clear Stream File If selected, this option clears the stream file before sending any more display data. If it is not selected, the display data will be appended to any existing contents.

Stream on Form Feeds
When this option is selected, data will be sent to the file each time a form-feed character is received, instead of on each line-feed. This option is intended for capturing complete screen displays from applications that do not send data to the screen line-by-line.

Chapter 6

Setting up Sessions

This chapter describes in detail how to set up Network and Asynchronous sessions. It covers those parameters that are essential to communication between a PC and a host system, and also those which are a matter of personal preference.

Introduction

There are many parameters which can be set up using RealLink and the various host configuration utilities. There are only a few, however, which are essential to communication between a PC and a host system. Almost all the commands you will need are found on the RealLink Setup menu (Figure 6-1), with the remainder on the Font menu.

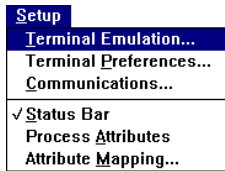

Figure 6-1. Setup Menu

The third item on the Setup menu, Communications is used to set up both network and asynchronous sessions. The remaining items are common to both network and asynchronous links.

Configuration Files

When you start RealLink and connect to a host, you need a configuration to specify parameters such as the type of terminal emulation, the host name or port number, and the number of lines and columns displayed in the RealLink window. The default RealLink configuration can be used in many cases without modification, but you may need to make changes in order to connect successfully and, as you become familiar with RealLink, you may want set up your own preferred configuration.

All the parameters mentioned above can be saved, together with other settings, in configuration files stored on your PC. When you want to connect to a particular host, you simply select the appropriate configuration file and initiate the connection. The contents of the file are used to configure RealLink for connection to the specified host and to set up your various preferences.

This chapter shows you how to create, modify and save configuration files, and describes the different parameters and preferences you can set.

Creating a New Configuration File

You create a new configuration file by selecting the New command from the File menu, or by starting RealLink without specifying a configuration file.

Notes:

- You can have only one configuration file loaded at a time. If you are currently connected to a host system, creating the new configuration file will necessitate breaking your connection to the host. The following message will appear.

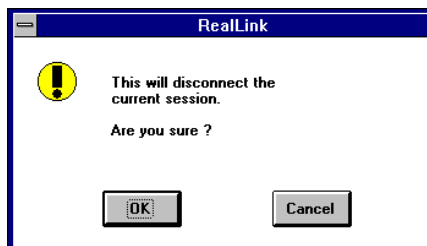

Caution

You should never disconnect without first logging off from the host. In the case of an asynchronous connection, this will simply leave you logged on - you can reconnect at a later time and continue where you left off, though this is not recommended for reasons of security. In the case of a LAN connection, however, the host will be disconnected and any open files closed - this could result in loss of data.

Select OK to disconnect from the host and create a new configuration file, or Cancel to continue the current session.

- If you already have a configuration file loaded and you have made some changes that have not yet been saved, you will see the following message:

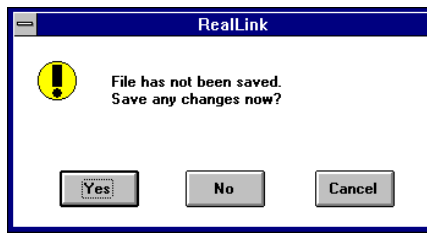

Click Yes to save the file, No to lose your changes or Cancel to continue working with the loaded configuration file.

Once you have disconnected any open session, and saved or discarded any changes to the previous configuration file, a new, default configuration will be created and the title of the RealLink window will change to the following:



You can now set up your new configuration as described in the sections which follow, and then save the file using the Save As command on the File menu.

Modifying an Existing Configuration

If you want to modify an existing configuration file, you must first load it into RealLink. Select the Open command from the File menu; you will see the dialog box shown in Figure 6-2.

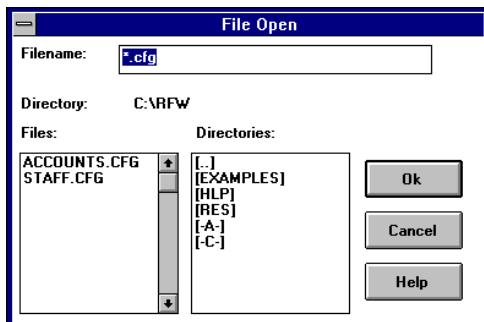

Figure 6-2. File Open Dialog

Select the required configuration file from the list on the left or type file name in the Filename text box. You can also use the list of directories to change to a different directory and/or disk drive before making your selection.

When you click OK, the selected file will be loaded. Note, however, that you can only have one configuration file loaded at a time. Refer to the notes in the previous section for details.

You can now set up your configuration as described in the sections which follow, and then save the file using the Save As command on the File menu.

Note: You can also make changes to your configuration while you are connected to a host. Some settings, however, will not take effect until the next time you connect.

Saving your Configuration File

When you have finished making your changes, you can save them in a configuration file. There are three ways of doing this - with the Save As and Save commands on the File menu, and the Save Window Position command on the Font menu.

Warning

If you create a new configuration and save it with the Save or Save Window Position command before you have used Save As, you will save your changes in RFWDEF.CFG, thus changing your default configuration.

- By selecting the Save As command from the File menu. You should use this command to save a new configuration, or if you have modified an existing configuration and want to give the new version a different name.

When you click the Save As command, the dialog shown in Figure 6-3 appears.

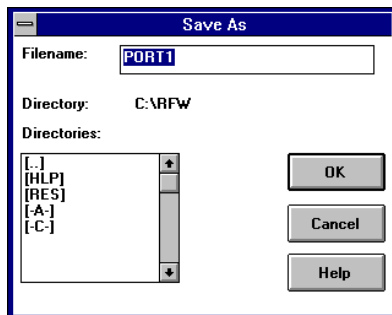
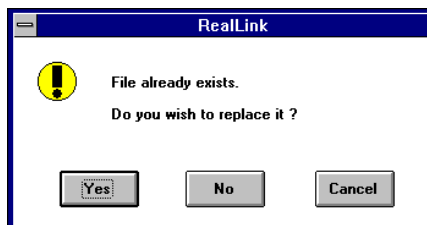

Figure 6-3. File Save As Dialog

Type the name for your configuration file in the Filename text box. The filename can consist of up to eight characters, plus a three character extension; if you do not specify an extension, the extension .CFG will be added to your filename automatically (you are recommended to use the extension .CFG, so that the file will be listed in the Connect and File Open dialog boxes). If you wish, you can use the list of directories to change to a different directory and/or disk drive before saving your configuration.

When you click OK, your file will be saved. Note, however, that if you have chosen the same name as an existing file, you will see the following message:



Choose Yes to overwrite the existing file, No to return to the Save As dialog, or Cancel to return to RealLink without saving.

Note: You cannot use a filename that is the same as a DOS device name. For example, you cannot use the filenames COM1.CFG or COM2.CFG.

- By selecting the Save command from the File menu. You will normally use this command to save changes to an existing configuration; the file will be saved without prompting you for a file name.
- By selecting the Save Window Position command from the Font menu (see page 6-81). You will normally use this command to save only the size and position of the RealLink window. You should be aware, however, that any other configuration settings that you have changed will also be saved.

The Default Configuration

Whenever you create a new configuration, it is based on the default RealLink configuration, stored in the file RFWDEF.CFG. The information in this file is loaded when you start RealLink without specifying a configuration file, when you select the New command from the File menu, and when you create a new configuration file by entering a host name in the Connect dialog.

If you wish, you can change your default configuration by selecting the required configuration options and then saving these as RFWDEF.CFG.

Note: To restore the original defaults, delete the file RFWDEF.CFG and then use File New to create a new configuration. A message will appear, warning you that RFWDEF.CFG cannot be found. Click OK and then use File Save As to save the configuration to a new RFWDEF.CFG file.

Setting up a Network Session

To set up a network session do the following:

1. Select the Communications command from the Setup menu (Figure 6-1). You will see the dialog box shown in Figure 6-4.

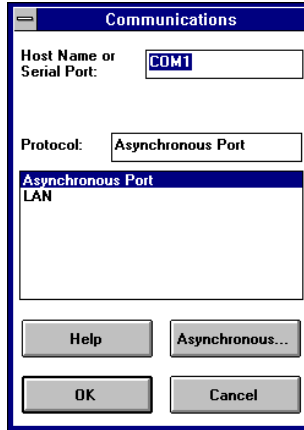

Figure 6-4. Communications Dialog

2. Choose LAN from the list of Protocols:
3. In the Host Name or Serial Port text box, enter the network name of the host to which you wish to connect:

For Network connections you will be able to connect to any host that can be resolved by TCP/IP, provided it supports the default protocol. The host does not have to appear in your SNI configuration file. Hosts that do not support the default protocol must, however, have an entry in the SNI configuration file - refer to the *PCI Standard Network Interface Installation Guide* for details.

This is the minimum necessary to set up a network session. You can now click OK to accept your changes and then use the File Save or Save As command to save your modified CFG file.

Note: If all your connections will be use the TCP/IP protocol, you can set the **EnableCallback** setting in the WINSNI.INI file. This will reduce CPU usage, and thus improve the performance of other PC applications. Refer to the *PCI Standard Network Interface Installation Guide* for details.

Setting Up an Asynchronous Session

Setting up an asynchronous session is less straight forward than for a network session, as there are more parameters which must be set before the session can be used.

The first thing that must be done is to specify the asynchronous port that you will use.

1. Select the Communications command from the Setup menu. You will see the dialog box shown in Figure 6-4.
2. Choose Asynchronous Port from the list of Protocols.
3. In the Host Name text box, enter the asynchronous line used for the connection: COM1, COM2, COM3 or COM4.

Asynchronous Dialog

You must now set the communication parameters for the line. Click the Asynchronous button; the dialog box which appears (see Figure 6-5) allows you to set the parameters described in the sections which follow.

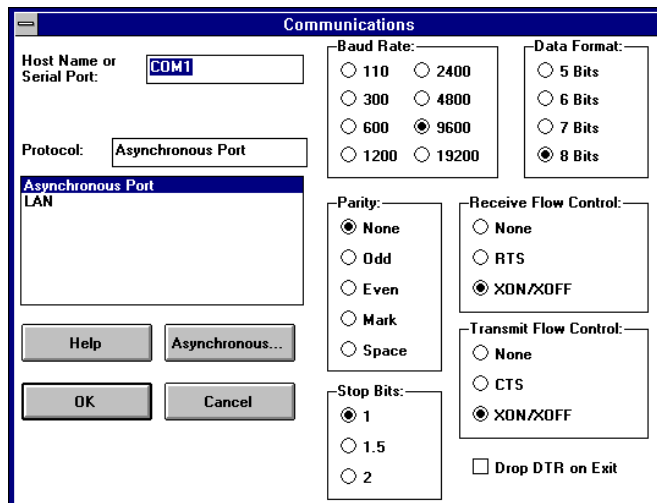

Figure 6-5. Asynchronous Dialog

Baud Rate

RealLink can be set to operate at any baud rate which is available on the PC. The baud rate selection buttons offer the following:

110, 300, 600, 1200, 2400, 4800, 9600, 19200

A communication speed of 19,200 baud is possible on most PCs, but it should be noted that IBM specify the maximum data rate for the Asynchronous Adaptors as 9600 baud. If you experience problems when running at 19,200 you should switch to a lower speed.

Parity

These selection buttons give you a choice of odd, even, space or mark parity. You can also choose to have no parity bit.

Data Format

These selection buttons allow you to set the number of data bits for each character.

Flow Control

There are basically two types of flow control:

- By the control characters XON/XOFF.
- By the RS232 signals RTS/CTS

RealLink is able to use either of these methods to control the flow from and to the host. You should ascertain from your local support centre whether your system attaches terminals using XON/XOFF or RTS/CTS.

PC flow control is selected by means of the Receive and Transmit Flow Control selection buttons in the Asynchronous dialog box. These offer the following:

No flow control
RTS (receive)/CTS (transmit)
XON/XOFF

Note: When connecting to SovereignX systems, you should use XON/XOFF flow-control for receive only. If you need transmit flow-control, use CTS.

You can use the same method of flow-control for both transmit and receive when connecting to Reality and UNIX systems.

Stop bits

This option allows selection of one, one and a half or two stop bits to be added to each character.

Drop DTR on Exit

This option allows you to specify whether the DTR (Data Terminal Ready) signal on the RS232 interface is to be turned off or left on whenever RealLink is closed.

For direct lines, DTR should normally be turned off. On network or modem connections, however, this could cause the line to drop, or result in a disconnection from the network. If you wish to maintain the connection, you should not select this option.

Terminal Emulation

The Terminal Emulation command on the Setup menu allows you to set the type of terminal emulation and the character set (nationality) used. When selected, the following dialog box appears:

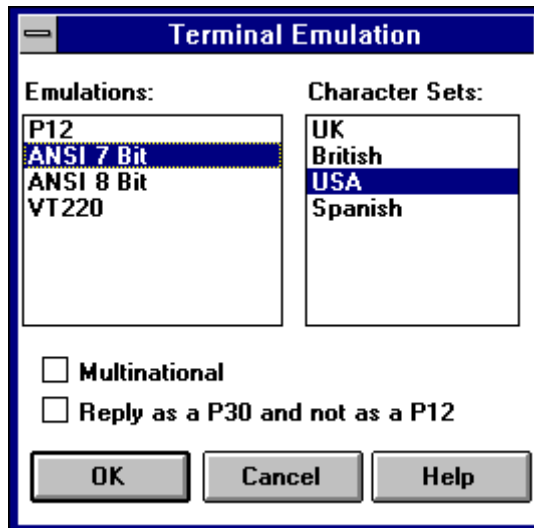

Figure 6-6. Terminal Emulation Dialog

Three of the terminal emulations offered by this dialog are the same as those offered by the Northgate P12/P14 terminals - Prism (P12), ANSI 7-bit and ANSI 8-bit. The fourth is a DEC VT220 emulation. In each case, the emulation of the terminal is implemented as far as is possible given the physical characteristics of the PC. The majority of the escape and control sequences recognised by the selected terminal are handled by RealLink.

For each type of emulation, the list box allows you to choose which national character set to use. You can also use the **Multinational** check box to choose whether or not the Extension character set will be the Standard National Extension character set or the Multinational character set.

Note: The UK and British character sets, are very similar, but in the former, characters 35 and 36 are the hash (#) and pound (£) symbols respectively, while in the latter, character 35 is the pound (£) symbol and 36 the dollar (\$).

The **Reply as a P30 and not as a P12** check box sets the terminal type returned by RealLink when this information is requested by a host application. You should normally select this option if you are connecting to a Sovereign system, but otherwise leave it unselected.

Prism Emulation

In P12 (Prism) mode, RealLink emulates a Prism terminal. It supports most of the functions available on a Prism terminal, including cursor positioning, screen printing, direct printing, PORT-DESPOOL or PORTOUT despooling, and Sovereign mode. However, you should note the following differences:

- Function keys

The keyboards of early PCs have only ten function keys (F1 to F10), compared with the eighteen on the Prism terminal. In RealLink Prism emulation, operations assigned to function keys F11 to F18 are obtained by combining the ALT key with keys F1 to F8. Refer to Chapter 5 for a list of the available combinations.

- History Pages

The maximum number of history pages is normally 255 (6120 lines). Fewer will be available, however, if the number of lines and/or columns in the RealLink window is increased, or if insufficient memory is available. See page 6-76 for details.

- Sovereign mode

Sovereign mode is only available if you have purchased the RealLink Sovereign extensions.

The following Prism functions are not available in RealLink:

- Multiple Active Screens
- Hard-copy Printing
- Downloading of Character Sets from the host
- Support for Terminal Executive programs downloaded by the host. However, most of the facilities provided by the SP terminal executive are standard features in RealLink, and the features of other terminal executive programs are provided by means of Dynamic Link Libraries (DLLs) that can be loaded when you install RealLink (see Chapter 3).

Note: The AutoPrint feature of the SP terminal executive is not supported.

ANSI Emulations

These emulate a Prism terminal operating in the corresponding ANSI mode. Refer to the Prism Terminal *Programmer's Reference Manual* for details.

VT220 Emulation

This is similar to ANSI 7-bit emulation, but cursor movement is the same as on a DEC VT220 terminal. RealLink also provides escape sequences for VT220 support (see Appendix B).

Table 6-1 lists the VT220 keys that have no equivalent on the PC keyboard, and the corresponding RealLink keys.

Table 6-1. VT220 Key Equivalents

| VT220 | RealLink |
|-------------|-----------|
| FIND | INSERT |
| SELECT | DELETE |
| INSERT HERE | HOME |
| PREV SCREEN | END |
| REMOVE | PAGE UP |
| NEXT SCREEN | PAGE DOWN |

| | |
|------|--------|
| PF1 | F1 |
| PF2 | F2 |
| PF3 | F3 |
| PF4 | F4 |
| HELP | ALT+F5 |
| DO | ALT+F6 |

Note that the functions of the INSERT, DELETE, HOME, END, PAGE UP and PAGE DOWN keys are determined by the application you are running. You can use the HOME, END, PAGE UP and PAGE DOWN keys to view history pages (as described in Chapter 5) or scroll the terminal window horizontally (see Chapter 2) by clicking the Compose button on the status bar before pressing the key or key combination you require.

Terminal Preferences

This command can be used to select the preferred operating configuration for the terminal emulation and to make settings applicable to the Microsoft Windows environment. When you select this command, the dialog box shown in Figure 6-7 appears.

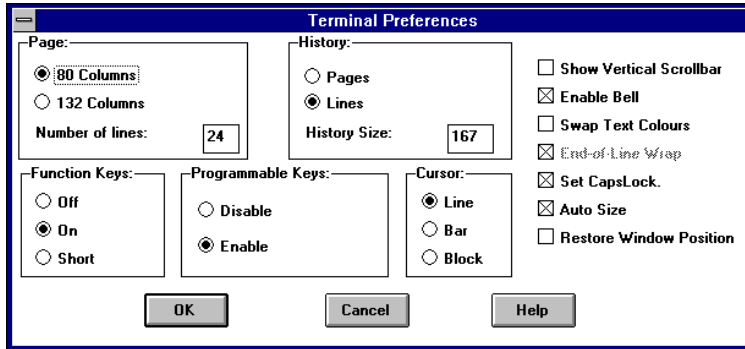

Figure 6-7. Terminal Preferences Dialog

Page Size

This group of functions allows you to select 80 or 132 characters as the width of the terminal page, and also to increase the number of lines (by entering the number required in the Number of Lines text box). The values that you select should also be set on the host, by using the TERM TCL command (refer to your Reality system manuals for details).

Note that the number of characters and lines actually displayed depends on the size of the RealLink window and the selected character size. If there are more columns than will fit in the window, a scroll bar appears across the bottom to allow the full width to be viewed. A scroll bar can also be displayed down the right-hand side of the RealLink window (see below), to allow history pages to be viewed.

History Pages

This option allows you to specify the amount of screen history that will be retained when you are using RealLink. You can specify this as either a number of pages or a number of lines. The page or line size is that currently selected using the Page Size functions (see above). The maximum number of history pages depends on the page size - for the standard 80 column, 24 line screen this maximum is 255 pages or 6120 lines; with larger page sizes, this number is reduced. The default is 7 pages or 167 lines.

Function Keys

The Function Keys and Programmable Keys options allow you to control the codes and messages generated by the PC function keys.

Function Keys:

- | | |
|-------|---|
| Off | This disables the function keys, unless Programmable Enabled is selected. |
| On | This causes the function keys to generate data sequences. |
| Short | This causes the function keys to generate single codes. This option is only available if P12 emulation is selected. |

Programmable Keys:

- | | |
|---------|--|
| Disable | If this option is selected, all function keys will generate the codes defined by the previous three options. |
| Enable | This option enables function key messages which have been programmed by the host. If a message has been defined for a particular key, this will override the code defined using the first three options. |

Cursor Type

The Cursor options set the character used for the text cursor in the RealLink window. You can select an underline character (Line), a vertical bar (Bar) or a solid block character (Block).

Other Options

The group of check boxes on the right of the dialog allow you to select other options.

Show Vertical Scrollbar

The Show vertical scroll bar option allows you to display or hide the vertical scroll bar on the right-hand side of the RealLink window. Check this box if you want to use your mouse to scroll back to any history pages. Note that you do not need a scroll bar to view the history pages; the PAGEUP and PAGEDOWN keys will scroll the history page even if no scroll bar is displayed.

Enable Bell

The Enable Bell option enables or disables the bell in RealLink. Check this box if you want to receive audible warnings from RealLink.

Swap Text Colours

The Swap Text Colours option allows you to swap the colours used for the foreground and background in the RealLink window. If this box is checked, the foreground and background colours of each screen attribute will be swapped when displayed on the screen. For example, if your screen normally displays black text on a white background, this feature will change the display to white text on a black background. Note, however, that the attribute settings (as set in the Attribute Mapping dialog - see page 6-79) remain unchanged.

End-of-Line Wrap

The End-of-line wrap option controls whether or not the cursor will move to the start of the next line when the right margin of the terminal page is reached (note that if the RealLink window is smaller than the terminal page, the window will scroll). If the box is not checked, the cursor remains in the last column and all characters typed are displayed at this position. The default is to wrap.

This option is only available in ANSI emulation. In Prism mode line wrapping is always enabled.

Set CapsLock

This option determines the state to which the CAPS LOCK is set when the CFG file is opened. Check this box if you want the CAPS LOCK to be set when you connect to the host.

On opening a CFG file, a record is kept of the CAPS LOCK settings both inside and outside RealLink. This is kept up to date as you move between RealLink and other applications, to ensure that the CAPS LOCK state is always what you expect.

Auto Size

When selected, this option changes the size of the font used in the RealLink window to suit the size of the window. It then adjusts the size of the window to display a complete terminal page, as set using the Terminal Preferences command on the Setup menu.

This option is the same as the Auto Size command on the Font menu.

Restore Window Position

When selected, this option causes the position and size of the RealLink window to be set to that saved in the currently loaded configuration file. If it is not selected, the RealLink default will be used. However, changing this option does not take effect until you next load the configuration file.

This option is selected automatically by the Save Window Position command on the Font menu.

Screen Attributes

RealLink is unable to display the majority of the screen attributes which are provided by a monochrome terminal (dim, flashing, etc.). Instead, it allows each combination of attributes to be translated into a foreground/background colour setting. This mapping of monochrome terminal attributes to colour settings is performed using the Attribute Mapping command on the Setup menu (Figure 6-1).

Notes:

- RealLink colours set with the Attribute Mapping command override the Window Background and Window Text colours which have been set using the Control Panel.
- The terminal emulator directly supports only the underline and blink attributes. Text that has the underline attribute set will be shown underlined in the RealLink window, and that with the blink attribute set will flash. However, the text concerned will also be displayed in the colours set with the Attribute Mapping command.
- Blinking can be disabled, if required, by changing the BlinkRate entry in the [RealLink] section of RFW.INI.

Attribute Mapping

RealLink can process any combination of the following screen attributes:

- Underline.
- Blank Video.
- Reverse Video.
- Blink (or Flashing).
- Reduced Intensity (or Dim).

Each of these attributes is assigned a foreground/background colour combination. Colours are assigned by using the Attribute Mapping command on the Setup menu.

Note: RealLink can also process the following line attributes:

- Double width.
- Double height, double width.

The Attribute Mapping Dialog

When you select the Attribute Mapping command, you will see the display shown in Figure 6-8.

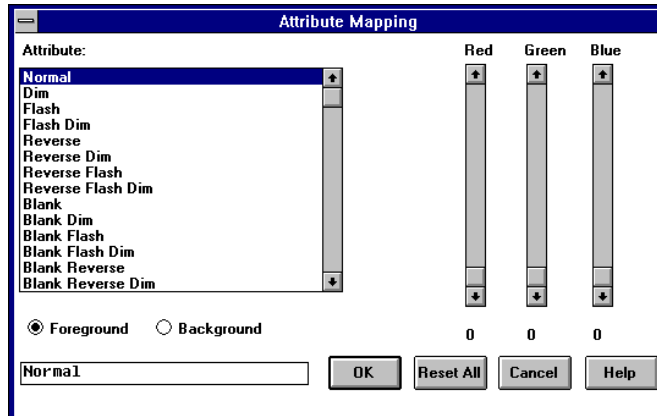

Figure 6-8. Attribute Mapping Dialog

The Attribute list box lists the 32 possible attribute combinations, while the box in the bottom left-hand corner of the dialog box shows the name of the currently selected attribute combination, displayed in its current foreground and background colours.

To change the colours assigned to a combination of attributes, select the appropriate entry in the Attribute list box and then choose foreground or background as required. You can then use the scroll bars on the right of the dialog box to select the combination of red, green and blue which corresponds to the colour you require.

Note: Although the scroll bars allow you to choose any setting between 0 and 225 for each of the three primary colours, RealLink will only allow you to select solid colours. This is to ensure that the displayed text remains readable.

The Reset button can be used to return the colours for all of the attribute combinations to the settings that were current when you selected the Attribute Mapping command.

Attribute Processing

The Process Attributes command on the Setup menu allows you to enable or disable the processing of screen attribute control sequences received by RealLink. If attribute processing is enabled (indicated by a tick on the Setup menu beside the command), attribute control sequences are processed. If attribute processing is disabled, attribute control sequences are ignored.

Note: Attribute processing reduces the performance of the RealLink display. If you do not need attributes displayed, you should disable this feature.

Font Control

The Font menu contains commands that allow you to control the size of the text displayed in the RealLink terminal window.

Enlarge

This command changes the font used in the terminal window to the next larger available size.



ALT+↑.

Reduce

This command changes the font used in the terminal window to the next smaller available size.



ALT+↓.

Very Small

This command reduces the font used in the terminal window to the smallest available size, and displays a complete terminal page at this size. The menu bar and status bars are removed from the window.

This command allows you to monitor the progress of background tasks on the host, while using other Windows applications.



ALT+←.

Note: If you press ALT+← while the RealLink window is at the very small size, the window is restored to its previous size, and the menu and status bars displayed.

Auto Size

This command controls the size of the text shown in the terminal window. When selected (marked with a tick), it causes the size of the font to change according to the size of the window. The size of the window is then adjusted to display a complete terminal page, as set using the Terminal Preferences command on the Setup menu.

This command is the same as the Auto Size option in the Terminal Preferences dialog box.

Save Window Position

This command saves the current position and size of the RealLink window. This information is saved in the currently loaded configuration file, and will therefore be used whenever this file is loaded.

Note: Any other settings that have been changed will also be saved.

Warning

If, when creating a new configuration, you use Save Window Position before you have saved your configuration with the Save As command, you will save your changes in RFWDEF.CFG, thus changing your default configuration.

Saving the window position automatically selects the Restore Window Position option in the Setup Terminal Preferences dialog (see page 6-76).

Maximise

This command is not on the Font menu, but on the System menu; click the box in the top left-hand corner of the RealLink window to display this menu.

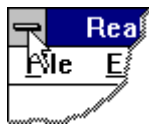

Selecting this command expands the RealLink window to fill the whole screen. If the Font Auto Size command is selected, the largest font available is also selected.



Click  in the upper-right corner of the RealLink window.
- or -
Double-click the window's title bar.



Press ALT+ →.

Chapter 7

File Transfer

You are unlikely to have a file format available that is common to DOS and the hosts to which you connect. In order that information from PC files can be used by programs on your host, and vice versa, RealLink provides a number of file transfer utilities. This chapter describes the following:

- A fast LAN file transfer utility for transfer between Reality or Sovereign, and the PC. This is available from the RealLink Tools menu.
- Reality host utilities for transfer over asynchronous links or local area networks.
- UNIX host utilities for transfer over asynchronous links or local area networks.

Introduction

The file transfer utility you should use depends on the type of host or environment to which you are connecting and the type of connection to that host. The available options are summarised in Table 7-1.

Table 7-1. File Transfer Utilities

| Host/Environment | Type of Connection | File Transfer Utility |
|------------------------------|---------------------------|--|
| Reality. | DDATCP. | LanFTU, WS-HOST, HOST-WS, PASS-DOS, SPASS-DOS. |
| | Telnet. | WS-HOST, HOST-WS, PASS-DOS, SPASS-DOS. |
| UNIX. | DDATCP, Telnet. | zmodem. |
| SOVEREIGN | DDATCP (replug via UNIX). | LanFTU (with Sovereign extensions). |
| SovereignX | DDATCP. | LanFTU (with Sovereign extensions). |
| SovereignX UNIX environment. | DDATCP. | LanFTU (with Sovereign extensions), zmodem. |

Refer to the *PCI Standard Network Interface, Installation Guide* for information about the different connection types.

LanFTU

The LanFTU command on the Tools menu allows you to transfer files to or from a Reality or Sovereign host via a LAN. You can do this at any time while RealLink is running; while you are connected via the LAN; while you are connected via an asynchronous link; or even while you are not connected to a host.

When you select the LanFTU command, you will see the dialog shown in Figure 7-1.

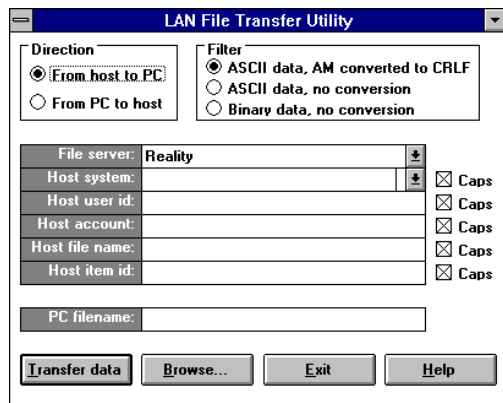

Figure 7-1. LanFTU Parameter Selection Dialog

Enter the following information:

- | | |
|-----------|--|
| Direction | Choose the required direction of transfer: from host to PC or from PC to host. |
| Filter | The options available in this group depend on the setting of the File server field. |
| | Reality: |
| | <p>ASCII data, AM converted to CRLF - Attribute marks (0xFE) in the Reality file are converted into carriage return, line feed (0x0D, 0x0A) in the PC file, and vice versa.</p> <p>ASCII data, no conversion - Copies with no translation.</p> <p>Binary data, no conversion - Copies raw binary data with no translation.</p> |
| | Sovereign: |
| | <p>Note: These options are only available if you have purchased the RealLink Sovereign extensions:</p> <p>Text data file transfer - Depends on whether you are transferring data to or from a Sovereign or a UNIX data file, and the direction of transfer:</p> <ul style="list-style-type: none"> • when transferring data from a Sovereign file to the PC, each record copied from the host is terminated with carriage return, line feed (0x0D, 0x0A); |

- when transferring data from the PC to a Sovereign file, a record is created for each line of the PC file and carriage return, line feed pairs are discarded;
- in a UNIX file, newline characters are converted to carriage return, line feed (0x0D, 0x0A) in the PC file, and vice versa.

Note: UNIX files can only be transferred to and from the UNIX environment on a SovereignX host.

Binary data file transfer -

Copies raw binary data with no translation.

File server

Choose one of the following:

- Reality - for transfer to or from a Northgate Series 19 host or a UNIX host running Reality.
- Sovereign - for transfer to or from a Northgate Sovereign or SovereignX host. This option is only available if you have purchased the RealLink Sovereign extensions.

Host system

The name of the required Reality or Sovereign host. This must be the name of a valid DDA connection listed in the SNI configuration file on your PC. If you click the down-arrow to the right of the field, you will see a list of the available connections. Refer to the *PCi Standard Network Interface Installation Guide* for details of how to set up your SNI configuration file.

Note: The connection you choose must use the DDA protocol. LanFTU cannot be used on character mode (Telnet or ACI) connections.

Host user id

The ID of a valid user on the host system.

Host account

The name of the account on this host, to or from which you wish to transfer the data.

Host file name

The name of the required file in this account.

Note that if you are transferring to or from a SovereignX UNIX environment, the file name must be in the form

ResourceName:FileName

where *ResourceName* is the name of a SovereignX UNIX resource created with the Resource Maintenance (RM) utility. Refer to your SovereignX manuals for more details.

Host item id (Reality only)

The Reality item-id of the item containing, or to receive the transferred data.

If you are transferring from host to PC, you can use an asterisk (*) to specify the entire file. The items will be concatenated, with a separator that depends on the filter selected:

- ASCII data, AM converted to CRLF - items are separated with carriage return, line feed.
- ASCII data, no conversion or Binary data, no conversion - the file starts with an attribute containing header information and each item is preceded by an attribute containing the name of the item.

Note: The Caps check boxes to the right of these five fields allow text entered to automatically be converted to upper case. This makes setting the CAPS LOCK unnecessary when entering Reality and Sovereign system names, etc.

Max Rec Size (Sovereign only)

The size of the largest record to be transferred (16384 bytes maximum).

PC filename

The full path name of the PC file containing, or to receive the data to be transferred. If you wish, you can click the Browse button and select a file from the dialog which appears (shown in Figure 7-2).

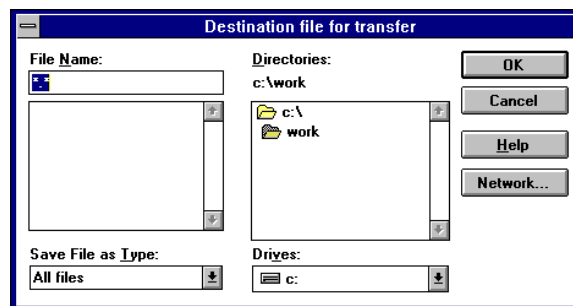
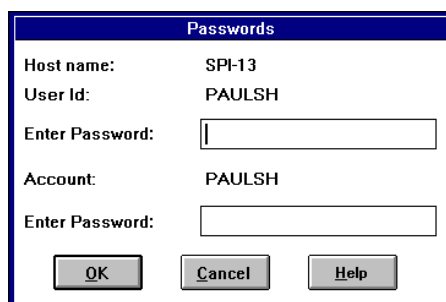

Figure 7-2. LanFTU Browse Dialog

When you click the Transfer data button, you will be prompted for your user-id and account passwords. For example:



Clicking OK will then establish the connection with the host and transfer the data. A message will appear when the transfer is complete and you will then be returned to the LanFTU Parameter Selection dialog.

If you wish, you can carry out a number of transfers before closing LanFTU. The first transfer establishes the connection to the host, and this connection is then used for any subsequent transfer, until you either close LanFTU by clicking the Exit button, or enter a different host system name. You are only prompted for your passwords when the connection is first established.

Note that you can return to RealLink (or select a different application entirely) without closing LanFTU.

When you leave LanFTU, your settings are retained for use as defaults the next time you use the command.

Reality Host Utilities

The Reality file transfer utilities are host programs which must be run once you are logged on. They can be used for transfer via both asynchronous lines and Local Area Networks. The following utilities are available:

| | |
|-----------|--|
| HOST-WS | This copies items from a Reality file into a DOS file on the PC. |
| WS-HOST | This copies data held in a DOS file on the PC, into items in a Reality file. |
| PASS-DOS | An English command that allows Reality data to be selected and processed through the file dictionary items. The result is written to a DOS file in the specific format expected by the DOS program which will subsequently access it (for example, in DIF format). |
| SPASS-DOS | An English command, equivalent to the PASS-DOS command, but which allows the data items to be sorted. |

HOST-WS

The HOST-WS command copies one or more items from a Reality file into a DOS file on the PC. Its syntax is as follows:

HOST-WS *host-file host-item DOS-file {filter}*

where

| | |
|------------------|---|
| <i>host-file</i> | is the name of the host file. |
| <i>host-item</i> | is the name of the item to be copied from this file. Note that you can use an asterisk (*) to specify the currently active select list; if there is no active select list, the entire file is selected. |
| <i>DOS-file</i> | is the name of the DOS file on the PC into which the data will be copied. |
| <i>filter</i> | is the name of a filter (optional). This can be one of the following: |
| FLT-C | Recovers DOS data stored in compressed format on the host. The same filter is used with WS-HOST to store the data on the host. |
| FLT-D | Saves data in Reality format in a DOS file. The data may be recovered by using the same filter with WS-HOST. |
| FLT-DOWN | Copies standard ASCII text, converting attribute marks to carriage-return/line-feed, and value and sub-value marks to spaces. Carriage-return/line-feed is appended to each item and a DOS end-of-file mark at the end of the file. |
| FLT-I | Performs the same conversion as FLT-DOWN, except that the item-id is included in the DOS file. No DOS end-of-file mark is added. |

| | |
|----------|---|
| FLT-NULL | Copies with no translation. |
| FLT-X | Performs the same conversion as FLT-DOWN, except that no carriage-return/line-feed or DOS end-of-file mark are added. |

You can also write your own filters if required - refer to Appendix C for details.

If no filter is specified to HOST-WS, a default filter is used. This copies standard ASCII text, converting attribute marks to carriage-return/line-feed, and value and sub-value marks to spaces. Carriage-return/line-feed is appended to each item.

If you specify fewer than three parameters, HOST-WS will prompt you until you have supplied all four (including the filter name).

When you start the transfer, a message similar to the following will appear, to report the progress of the operation.

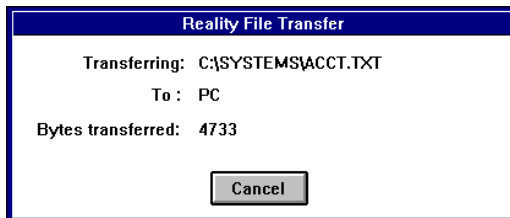

Example 1

Copy the item 1769 from the host file STAFF to the DOS file MEMBER.TXT in the current DOS directory. Use the filter FLT-I.

```
HOST-WS STAFF 1769 MEMBER.TXT FLT-I
```

Example 2

Copy the item ACCOUNTS from the host file SYSTEMS. HOST-WS prompts for a DOS file name and the name of a filter as shown.

```
HOST-WS SYSTEMS ACCOUNTS  
To WORKSTATION file: C:\SYSTEMS\ACCT.TXT  
Filter Name: FLT-DOWN
```

WS-HOST

The WS-HOST command copies data from a DOS file on the PC, into an item in a Reality file. It has the following syntax:

```
WS-HOST host-file host-item DOS-file {filter}
```

where

host-file is the name of the host file.

host-item is the name of the item in this file into which the data will be copied.

DOS-file is the name of the DOS file on the PC from which the data will be copied.

| | |
|---------------|---|
| <i>filter</i> | is the name of a filter (optional). This can be one of the following: |
| FLT-C | Saves DOS data on the host in compressed format. The same filter may be used with HOST-WS to recover the data. |
| FLT-D | Recovers data saved in Reality format in a DOS file. The same filter is used with HOST-WS to store the data on the PC. |
| FLT-UP | Copies standard ASCII text. Tabs are converted to spaces and carriage-returns to attribute marks. Line-feeds are discarded. |

You can also write your own filters if required – refer to Appendix C for details.

If no filter is specified to WS-HOST, a default filter is used. This copies standard ASCII text, converting tabs to spaces and carriage-returns to attribute marks, and discarding line-feeds.

If you specify fewer than three parameters, WS-HOST will prompt you until you have supplied all four (including the filter name).

When you start the transfer, a message similar to the following will appear, to report the progress of the operation.

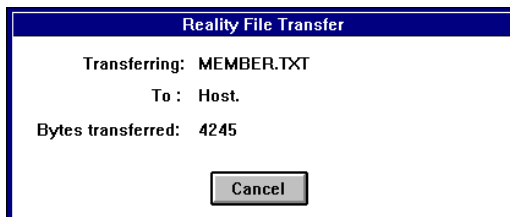

Example 1

Copy the file MEMBER.TXT in the current DOS directory to item 1327 in the host file STAFF. Use the filter FLT-UP.

```
WS-HOST STAFF 1327 MEMBER.TXT FLT-UP
```

Example 2

Copy a DOS file to the host file DEPTS. WS-HOST will prompt for the item name, the DOS file name and a filter name.

```
WS-HOST DEPTS  
To HOST Item: PRODUCTION  
From WORKSTATION File: C:\DEPTS\OUTPUT.TXT  
Filter Name: FLT-UP
```

PASS-DOS and SPASS-DOS

PASS-DOS and SPASS-DOS are additional English commands. They convert Reality data into the format required by a specific DOS program and then use HOST-WS to transfer the converted data to one or more DOS files.

If you are unfamiliar with the Reality English query language, you should refer to the *English Reference Manual* before proceeding with this section.

Command Format

PASS-DOS is equivalent to the English command LIST, while SPASS-DOS is equivalent to SORT. Both commands can use any of the normal English clauses.

One additional clause, INTO, is required to define the type of conversion required and the target DOS file. The keyword INTO must be followed by a quoted string containing this additional information. The INTO clause can be used anywhere in the English sentence, with the exception that any FOOTING clause must come *after* the INTO clause. If a FOOTING clause precedes the INTO clause, it will be treated as an INTO clause, with unpredictable results.

The format of the INTO clause is as follows:

```
INTO "filter drive:{path}DOS-file"
```

where:

filter is the name of a filter that will convert the data into the required format. The available filters are listed below.

drive:{path}DOS-file is the name of the destination file. Note that you *must* specify the drive letter, but that the directory path is optional. If you do not specify a path, the file will be created in the current directory.

Note that the following Output Format Modifiers are ignored:

```
TOTAL  
GRAND-TOTAL  
BREAK-ON  
DBL-SPC
```

Filters

The file created will be in the format required by a specific target DOS application. You should consult the documentation for your DOS application to determine which data formats it can import.

Note: Many DOS packages are able to import data in the format known as DIF - Data Interchange Format. The DIF format is discussed in Appendix C.

The following filters are available for use with PASS-DOS and SPASS-DOS:

| | |
|------|---|
| BDIF | Creates a basic form of DIF file without a DIF TABLE item and without LABEL items. It can be used for any program which does not properly handle these optional DIF fields. |
| CD | Creates a file in the comma-delimited format used as input to a number of PC packages. Column headings (attribute names) are not included. Each attribute is enclosed in double quotes. |
| CDH | This is similar to the CD filter, but the first line of the file contains column headings. This format is suitable for use as input to the mail merge features of PC applications such as Microsoft Word for Windows. |

| | |
|---------|---|
| DIF | Creates a file in the full DIF format which includes a TABLE item and LABEL items. |
| DW3 | Creates a file in a DIF format, suitable for input to the IBM Displaywrite 3 package. Displaywrite 3 accepts several forms of mail-merge data but the DIF format is the preferred one. |
| LOTUS | Creates a DIF file for input to Lotus 1-2-3 which puts the attribute names at the top of the columns. The DOS file will have the forced extension of .DIF. |
| MMATE | Creates a DIF file for input to MultiMate 3.4 onwards for mail-merge lists. |
| MPLAN | Creates a file in the SYLK format for input to Multiplan. The DOS file will have the forced extension of .SL. |
| MSBASIC | Creates a comma-delimited file in a format which can be read by Microsoft BASIC programs using the INPUT# statement. The data is preceded by a section which includes field names, left/right justification and length from the Reality dictionary items. |
| SAMNA | Creates a file in the DIF format required for input to the Samna word processing package for incorporation into its internal mail-merge records format. The format is also used for the Samna Decision Graphics package. |
| SYLK | Creates a file in the SYLK format, as for the MPLAN filter, but without the forced .SL extension. |
| WPF | Creates a file in the WordPerfect mail-merge format. |
| WSMM | Creates two files, one containing the WordStar mail-merge data and the other containing the template for insertion into a WordStar merge document naming the fields. The template file is given the extension .TMP. |

Note: All the filters listed above discard headings and footings, whether generated by default or by the inclusion of specific HEADING or FOOTING clauses.

Data Presentation

Because PASS-DOS and SPASS-DOS are true English verbs, all data output to the DOS file is processed through attributes seven and eight of the dictionary item. It appears the same in the DOS file as it would on the screen as a result of a similar LIST or SORT command.

Attributes nine and ten of the dictionary item will also affect the data extracted from the Reality file:

- Attribute nine is used to determine whether the data is to be treated as numeric or alphabetic by the DOS program. In these instances, L is assumed to be alphabetic while R is assumed to be numeric if the data is also numeric in content.
- Attribute ten often determines the cell size for DOS spreadsheet files such as those in the SYLK format.

Example 1

Create a file containing the attributes NAME and DEPT taken from the STAFF file. The DOS file will have the name MERGE.DAT and be in WordPerfect Mail-Merge format. It will be created in the \WP directory on drive C:.

```
PASS-DOS STAFF INTO "WPF C:\WP\MERGE.DAT" NAME DEPT
```

Example 2

Create a DOS file called STAFF.DTA in the \WS directory on drive C:. The file will contain the same information as in the previous example, but will be in WordStar Mail-Merge format. A WordStar template file with the name STAFF.TMP is also created.

```
PASS-DOS STAFF INTO "WSMM C:\WS\STAFF.DTA" NAME DEPT
```

UNIX Host Utilities

RealLink supports the use of the industry standard Zmodem protocol for file transfer between UNIX hosts and the PC over both asynchronous links and local area networks. Transfer must be initiated from the host, by calling the rz (PC to host) and sz (host to PC) programs - refer to your UNIX documentation for details of these.

Note: Most UNIX systems do not include rz and sz as standard. Your host system manager will tell you whether they are available on your system.

Transfer to the Host

File transfer from the PC to the host is initiated by entering the following command:

rz

Note: There are a number of options to the rz command. Your UNIX documentation will give you full details of these.

When you press RETURN, you will see the dialog box shown in Figure 7-3.

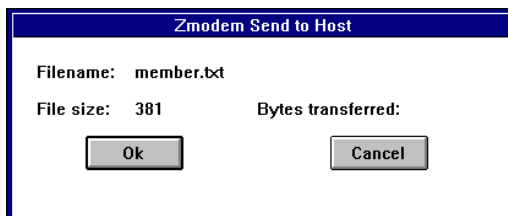

Figure 7-3. RZ File Transfer Dialog

Enter the name of the file you wish to transfer and click the OK button. As the transfer proceeds, the number of bytes transferred are shown on the right-hand side of the dialog. When the transfer is complete, the dialog box will disappear and you will be returned to the UNIX prompt.

The Set FTU Path command on the Tools menu allows you to specify the PC drive and directory containing the file to be transferred. When you select this command, the dialog shown in Figure 7-4 appears.

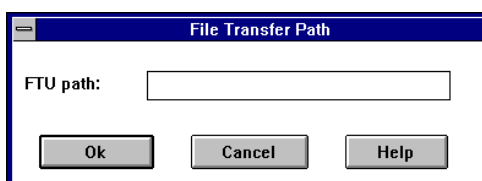

Figure 7-4. File Transfer Path Dialog

If you do not set a drive and/or directory path, the source file is assumed to be in the current directory.

Caution

If the file name entered into the RZ File Transfer dialog includes a path, this will form part of the name of the file created on the host. For example, if you enter C:\STAFF\MEMBER.TXT, a file called c:\staff\member.txt is created on the host (note the change to lower case). Since the colon and backslash are not legal

characters in UNIX filenames, this may present problems when using the transferred files.

Transfer to the PC

File transfer from the host to the PC is initiated by entering the following command:

sz filename

where *filename* is the name of the required UNIX file.

Note: There are a number of options to the *sz* command. Your UNIX documentation will give you full details of these.

When you press RETURN, you will see a message similar to that shown in Figure 7-5.



Figure 7-5. SZ File Transfer Dialog

As the transfer proceeds, the number of bytes transferred are displayed. When the transfer is complete, the dialog box will disappear and you will be returned to the UNIX prompt.

The transfer process creates a DOS file in the directory specified with the Set FTU Path dialog (see Figure 7-4), overwriting any file with the same name which already exists. If no path has been set, the current directory is used.

Chapter 8

Macros

RealLink macros allow you to automate tasks that you carry out frequently and that are time consuming if carried out by hand. This chapter describes:

- The parts of a macro.
- How to write a simple macro.
- How to load a macro into RealLink so that you can use it.

It also contains a detailed description of the RealLink macro language and the commands you can use, together with a list of the error messages that you might see when you are writing and testing macros.

Introduction

A RealLink macro is a text file containing one or more object definitions. An object can be an executable script, a toolbar definition, or a function-key definition.

A macro file can be produced using any text editor or word processor (provided it is saved in ASCII format). The Macro Select command on the Macro menu includes an Edit button that allows you to edit existing macros with the Windows Notepad utility.

Script Objects

A script object consists of a sequence of commands that carry out actions, such as:

- Connecting to a host.
- Prompting the user for a password.
- Sending text to the connected host.
- Waiting for the host to send a particular text string to the terminal.
- Displaying messages.

There are several ways of executing a script:

- You can assign the script to a menu command, so that it will be executed when the user selects that command.
- You can assign the script to a Toolbar button; it will then be executed when the user clicks the button.
- You can assign the script to a function key (or key combination).
- You can assign the script to a mouse button (with or without one or more modifier keys).
- You can give the script a special name which will cause it to be executed automatically when you select the macro from the menu.
- You can call it from another script, provided the macro containing the called script is currently loaded.

Menu Commands

RealLink macros allow you to define additional menus, either on the menu bar (pull-down menu), or to appear at the current position of the mouse pointer (pop-up menus). Both types of menu will normally contain commands that execute script objects or individual macro commands, but can also include further 'cascaded' menus.

Your macro can dynamically modify the menus that you have defined. You can add extra commands, change existing ones and disable commands that are inappropriate.

Note: You cannot change the standard RealLink menus.

Toolbars

A Toolbar is an area of the RealLink window containing one or more buttons that can be clicked by the user to execute script objects or individual macro commands. The buttons on a Toolbar can have text captions, or graphic icons.

Any Toolbar defined in a macro file is added to the RealLink window when the macro is loaded. Up to two Toolbars can be displayed in the RealLink window at the same time: one at the top of the window, just below the menu bar, and the other at the bottom, below the status bar.

Function-key and Mouse Button Definitions

A macro file can include definitions for the mouse buttons and the keyboard function keys, when used on their own and in combination with the SHIFT, CTRL and ALT keys. You can assign script objects or individual macro commands to these buttons and keys. Any definitions defined in a macro file become available when the macro is loaded.

Writing a Simple Macro

The following macro consists of a single script object, a Toolbar object containing a single button, and a key-definition object. The script allows a user called JIM to log on to the "STAFF" account on a Reality system. A configuration file called HOST1.CFG has been created to allow you to log on to the host. To try this example, you should substitute your own configuration file, user and account names.

Note: The macro below assumes that you will be prompted for a User ID, user password and account name. If you have a default account, you can omit the statements that wait for the account name prompt and send the account name.

You can use any text editor or word processor to produce the macro file. If you use a word processor, remember to save the macro in ASCII text format. Start your editor or word processor and create a new file. Then enter the following:

```
Object Staff Is Script; ❶
    Timeout(5); ❷
    On Connect("C:\RFW\HOST1.CFG") Goto Fail; ❸

    On WaitFor("LOGON PLEASE:") Goto Fail; ❹
    SendLine("JIM");

    On WaitFor("Password:") Goto Fail; ❺
    Password("Please enter your password.");
    SendLine("");

    On WaitFor("Enter account name:") Goto Fail; ❻
    SendLine("STAFF");
    Return;

Fail:
    Msg(INF01, "Staff", "Failed to connect to HOST1"); ❼
EndObject Staff. ❽
```

- ❶ This line introduces the definition of a script object called "Staff". Note that, with one exception which will be mentioned later, all macro statements must end in a semicolon. Note also that the script language is not case sensitive; the following are all equivalent: Object, object, OBJECT, obJect.
- ❷ This line sets the time in seconds that the WaitFor statement will wait for a response before assuming that an operation has failed.
- ❸ This line attempts to connect to the host specified in the HOST1.CFG file (substitute the name and path of your CFG file). Note that the complete path of the CFG file must be specified. The On...Goto structure allows you to take different actions, depending on whether the connection is successful. In this case, if connection fails, the script will jump to the label "Fail".
- ❹ The script now waits for the host to print the log-on prompt, "LOGON PLEASE:" (if your host prints a different logon prompt, you can change this text).

When the prompt appears, the user name "JIM" is sent to the host; SendLine will append a carriage return. If, however, the prompt is not displayed within 5 seconds, the script jumps to the label "Fail".

- ⑤ The script now waits for the host to prompt for the user's password (if your host prints a different password prompt, you can change this text). When the prompt appears, the script will display a dialog box to prompt the user for the password. Once again, if the prompt fails to appear within 5 seconds, the script jumps to the label "Fail".

Note that when the user enters the password, this will be sent to the host without a terminating carriage return. The Password command is therefore immediately followed by SendLine.

- ⑥ Finally the script waits for the host to prompt for the account name (once again, you can change this text if necessary). When the prompt appears, the account name "STAFF" is sent to the host (with a terminating carriage return). The Return statement then prevents the script continuing.
- ⑦ If at any point, the script has jumped to the label "Fail" on the previous line, a message box will be displayed, to tell the user that the connection failed. The message box will have the title "Staff", an information icon, and a single "OK" button.
- ⑧ The EndObject statement marks the end of the Staff script. Note that it must be terminated with a full stop, not a semicolon.

The remainder of the macro provides the user with two methods of running the Staff script. At the end of the macro file enter the following:

```
Object Button Is Toolbar Above Plain; ①
    "Staff" = Call Staff; ②
EndObject Button.
```

```
Object Keys Is Keyactions; ③
    Ctrl + F5 = Call Staff; ④
EndObject Keys.
```

- ① This line introduces the definition of a Toolbar object called Button. It will be positioned at the top of the RealLink window, below the menu bar, and will have the Plain style.
- ② This line defines a button with the title "Staff" which, when clicked, will run the Staff script.
- ③ This line introduces the definition for a Keyactions object; that is, a list of function-key definitions.
- ④ This line specifies that the Staff script will be run when the user presses the CTRL+F5 key combination.

When you have entered all the above, save your macro in a file called STAFF.MAC, in your RealLink directory.

You can try out your macro by adding it to the RealLink Macro menu as described below and then selecting it from the menu. When the button bar appears, click the Staff button or press CTRL+F5 to logon to your host.

Notes:

- If you change the name of the script to FIRST, it will be executed automatically when the macro is loaded.
- You can find other example macros in your RealLink program directory.

Loading a Macro

Before it can be used, a macro must be loaded into RealLink. This can be done in two ways: you can use the Macro Select command to add it to the Macro menu - you can then select it when required; or you can load it when RealLink starts, by adding it to the RFW command line.

Note: If a macro contains a script called FIRST, this will be executed automatically when the macro is loaded.

The Macro Select Command

The Macro Select command on the Macro menu displays the following dialog box:

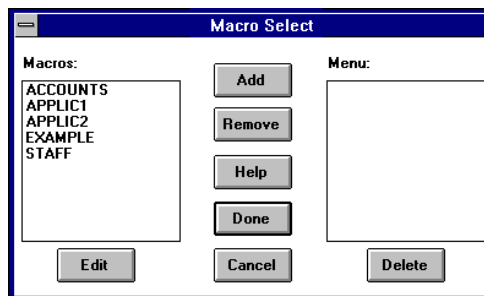

Figure 8-1. Macro Select Dialog

On the left of this dialog box, is a list of the macro files found on the disk. The files listed will be those found in the directory specified in the RFW.INI file (see Appendix A). On the right of the dialog box the macros currently available on the Macro menu are listed.

Adding a Macro to the Menu

To add a macro to the Macro menu, select the macro required from the Macros list and then click the Add button. The macro you have selected will appear in the Menu list.

The Macro menu can include up to nine macros. If you wish you can select several macros and add them to the menu in one operation. Any macros that are already on the menu will not be added a second time.

Note: You can choose the order in which your macros will appear on the menu by selecting an existing Menu entry before clicking the Add button - the new macros will be added before the selected macro. If nothing is selected in the Menu list, the new macros are added to the end of the list.

When you have finished adding macros to the menu, click the Done button. When you next pull down the Macro menu, it will contain the macros you added. For example:

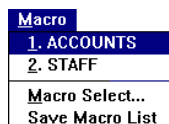

In this example, the ACCOUNTS and STAFF macros have been added to the menu. To load one of these macros, simply select the appropriate command from the menu.

Note: The changes you make to the Macro menu with the Macro Select command are only temporary - they will be lost when you close RealLink. If you want to

keep your changes for use in the future, you must use the Save Macro List command to save them in RFW.INI.

Removing a Macro from the Menu

You can remove macros from the menu by selecting them in the Menu list box and clicking the Remove button. The macros remain on the disk and can be added to the menu again by using the Add button.

Editing a Macro

If you want to edit a macro, select it in either the Macro or the Menu list box and click the Edit button. If more than one macro is selected, only the first one in the list is opened.

The editor used can be specified in the RFW.INI file (see Appendix A) - the default is Windows Notepad. If no editor is specified, the Edit button does not appear in the dialog.

Deleting a Macro from the Disk

You can delete a macro file from the disk by selecting it in either the Macro or the Menu list box and clicking the Edit button. If macros are selected in both list boxes, those in the Macro list box will be deleted.

Note: If no editor is specified in the RFW.INI file, the dialog will not contain a Delete button.

Loading a Macro from the Command Line

If you want a macro to be loaded when you start RealLink, you can use the Program Manager Properties command to add the /M switch to the RFW command line. The syntax of this switch is as follows:

*/M**Macro*

where *Macro* is the name of the macro to be loaded. There must be no space between the /M and the macro name. For example:

```
RFW.EXE /MSTAFF
```

starts RealLink and loads the macro called STAFF.

The Script Language

Object Definitions

A RealLink macro is an ASCII text file containing one or more object definitions. An object definition has the format:

```
Object Name Is Type {Options} ;
    Instruction ;
    { ... }
EndObject Name .
```

where:

- *Name* is a unique name, identifying the object.
- *Type* is the type of object: **Keyactions**, **Mouseactions**, **PopupMenu**, **PulldownMenu**, **Script** or **Toolbar**.
- *Options* is one or more object-dependent optional parameters.
- *Instruction* is a macro command. You can include any number of macro commands between the **Object** and **EndObject** statements.

Each command except **EndObject** must be terminated with a semicolon. The **EndObject** command must be terminated with a full stop.

There is no hard and fast rule for the layout of an object definition. The statements need only be separated from each other by white space (spaces, tabs and newlines). The programming style used in this chapter is recommended, however, since it makes clear the structure of the macro.

Notes:

- If a macro contains a script called **FIRST**, this will be executed automatically when the macro is loaded.
- A called script need not be part of the same macro as the calling object. However, the names of all loaded objects must be unique. Additional macro files can be loaded by using the **Load** statement.

Other types of object are defined within the **Object...EndObject** structure:

- A **Toolbar** object will contain one or more **Button** objects.
- A **PopupMenu** or **PulldownMenu** object will contain one or more **Menu** or **MenuItem** objects (see below).

You can also use the **Define** command to create **Button** and **MenuItem** objects.

Pull-down Menus

The **PulldownMenu** object allows you to add menus to the RealLink toolbar - the menus you add will appear to the right of the Help menu. In most cases your menus will contain only menu commands (menu items) which execute macro scripts or individual macro commands, but they can also include sub-menus (cascading menus), containing more commands. Figure 8-2 shows a possible structure.

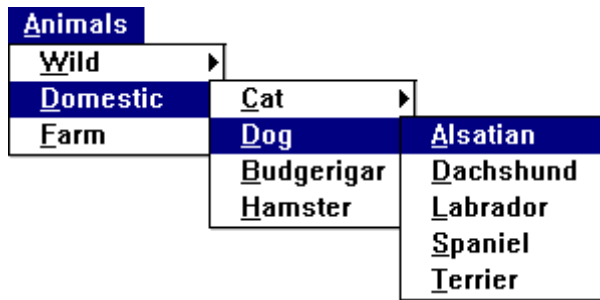

Figure 8-2. Pull-down and Cascading Menus

Each menu command is a separate **MenuItem** object, that defines the text to appear on the menu for that item and the macro command or script to be executed. A **MenuItem** definition has the following syntax:

```
{ ItemName Is } MenuItem Title$ [ Do | = ] Instruction ;
```

where:

- *ItemName* is a unique name to identify the object. **MenuItem** names are optional.
- *Title*\$ is the text to appear on the menu.

If required, you can designate one character in this text to act as a selector character (shown underlined when displayed) that the user can type to choose the command. This is done by preceding the character concerned with an ampersand (&).

- *Instruction* is a macro command.

You can also create separator items on your menus. These appear as horizontal lines across the menu and are used to divide the menu into groups of related commands. Separator items cannot be selected by the user. To create a separator item, give your menu item the title "-" (a hyphen); since the user cannot select a separator item, you can omit everything following the title:

```
{ ItemName Is } MenuItem "-";
```

Cascaded menus are **Menu** objects, containing **MenuItem** objects and, if required, other **Menu** objects. A **Menu** object definition has the following syntax:

```
{ MenuName Is } Menu Title$ {
    MenuItemDefinition ;
    { ... }
};
```

where:

- *ItemName* is a unique name to identify the object. **Menu** names are optional.
- *Title*\$ is the text to appear on the menu. As with **MenuItem** objects, you can use an ampersand to designate one character of the title as a selector character.
- *MenuItemDefinition* is a **MenuItem** or **Menu** object definition. You can include any number of menu-item definitions between the **Object** and **EndObject** statements.

Pop-up Menus

You can also define menus that are not attached to the ReaLink menu bar. These 'pop-up' menus are not normally available to the user, but can be displayed when required by calling the **Draw** macro command. For example, you might define a **Mouseactions** object that draws a pop-up menu when the user clicks the right-hand mouse button with the CTRL key held down.

Changing Objects

The **Define** macro command allows you to modify buttons, menus, menu items and toolbars, and to create new buttons and menu items.

- You can add new menu items to a pull-down, pop-up or cascaded menu. The menu items can be newly created or moved from another menu.
- You can change the title of a pull-down menu, cascaded menu or menu item.
- You can change the macro command associated with a menu item.
- You can add new buttons to a toolbar. The buttons can be newly created or moved from another toolbar.
- You can change the title or graphic displayed on a button.
- You can change the macro command associated with a button.
- You can create a new object with no parent. The type of object (button or menu item) will be determined when you add it to a menu or toolbar.

For more details, refer to the description of the **Define** command on page 8-100.

Flow Control

The **On...Goto**, **Goto** and **Return** statements allow you to control the execution of your script. **On...Goto** lets you branch to different parts of a script, depending on the result of an action. **Goto** branches unconditionally to another part of the script. **Return** terminates execution of the script and returns control to ReaLink, or to the calling script as appropriate.

The following shows a typical **On...Goto** structure:

```

On Action Goto Destination1, Destination2 ;

    Statements /* executed if neither destination is selected */
    Goto End ;

Destination1
    Statements /* executed if destination 1 is selected */
    Goto End ;

Destination2
    Statements /* executed if destination 2 is selected */
    Return ;

End
    Statements /* continuation of script */

```

In this example, the *Action* command returns a value which is used by the **On...Goto** statement to select one of the destinations in the list. If the return value is 0, destination 1 is selected and the script branches to that point. If the return value is 1, destination 2 is selected, and so on. If there is no destination in the list that corresponds to the value returned, the script does not branch.

The **Goto** statements at the end of the first two sections cause the script to branch to a section that is executed irrespective of the result of the *Action* command. Note, however, that because the third section (destination 2) ends in a **Return** statement, in this case the script will not continue beyond this point, but will return to ReaLink or to the calling script.

All macro commands return values that can be used in an **On...Goto** statement (normally 1 for success or 0 for failure). The following statements, however, return values that specify the completion status in greater detail:

Connect
Disconnect
Msg
WaitFor

Refer to the descriptions of these commands for details of their return values.

User defined scripts can also return values if required. The **Return** statement accepts an optional integer parameter which is returned to the calling script.

Labels

The **Goto** and **On...Goto** statements require you to specify lines to which to branch. These lines must be identified by labels.

The syntax of a label is as follows:

Identifier :

where *Identifier* is a string consisting of any combination of letters and digits up to a total of 100 characters, starting with a letter. For example:

Fail:
B2:
disconnect:

When a label is used in a **Goto** or **On...Goto** statement, the identifier must be used without the terminating colon: For example:

Goto Exit
.
.
.
Exit:

Note that you must use the same combination of upper and lower case letters as in the label definition.

Labels may appear at any position in a line, but it is suggested that, for clarity, they should be the first item on a line.

Strings

Certain macro statements require string parameters, which must be enclosed in double quotation marks. Control characters can be included in the text by using the following sequences:

```
/a  Alert (bell)
/b  Backspace
/f  Form feed
/n  Newline (line feed)
/r  Carriage return
/t  Tab
//  Slash
```

Other control characters can be specified by using a two-character hexadecimal value preceded by a slash. For example, to send a carriage return, you could use `"/r"` or `"/0D"`.

Note: Because a string must be enclosed in double quotation marks, if you need to include a double quotation mark in a string, you must specify it in hexadecimal; that is as `"/22"`.

Comments

Comments may be included in the macro file at any point except within literal strings or in the middle of a word. A comment can be indicated in several ways:

- It can be placed between the characters `'/*'` and `'*/'`, as in the C programming language. For example:

```
/* These two lines
   form a single comment */
```

- It can be placed on a separate line which starts with an asterisk (`*`), a hash (`#`) or two slashes (`//`). For example:

```
# This is a comment.
// So is this.
* And so is this.
```

- It can be placed on the end of a line, if preceded by the characters `'*'`, `'#'` or `'//'`. For example:

```
Timeout(5);           * 5 sec timeout
On Waitfor("Enter account name:") Goto Fail;
SendLine("STAFF");   # Send account name
Return;              // Return to ReaLink
```

Command Reference

The following sections list the RealLink macro commands and objects in alphabetical order.

Button Object

Defines a button that will appear on a Toolbar. The user can click the button to run a macro script or execute a single macro command.

Syntax

```
{ ButtonName Is } String$ { [ Do | = ] Instruction } ;
```

ButtonName This is an optional name for the **Button** object. Specifying a name allows you to enable and disable the button.

String\$ This can be either the text to appear on the button, or the name of a bitmap (.BMP), icon (.ICO), program (.EXE) or Dynamic Link Library (.DLL) file containing a graphic to display on the button. Unless you specify the path name of the file in full, it is assumed to be in the directory specified by the Bitmaps entry in the RealLink section of the RFW.INI file. In the case of icon, program and DLL files containing more than one icon, the first one will be used.

Instruction This must be one of the following macro commands:

| | | |
|----------|--------|----------|
| Call | Draw | Maximise |
| CapsLock | Enable | Minimise |
| Connect | Exec | NumLock |
| Define | Exit | SendLine |
| Disable | Load | SendText |

The button definition must be terminated with a semicolon.

See also

Toolbar object.

Example

```
Object Top is Toolbar Above Recessed;
  // text buttons
  "Reality" = Call Reality;
  "Unix" = Call Unix;

  Space(10);

  // bitmap buttons
  "vcrplay.bmp" = SendLine("play");
  "vcrstop.bmp" = Call Stop;
  "vcrpause.bmp" = SendLine("pause");
  "vcrend.bmp" = SendLine("end");
EndObject Top.
```

This example defines a recessed toolbar that will be displayed at the top of the RealLink window. The first two buttons will have the text labels "Reality" and "Unix".

There will then be a 10 pixel gap before a group of four buttons, each with a graphic icon.

Call

Transfers control to the first statement in the specified script. When the end of the script is reached, or a **Return** statement is encountered, control returns to the calling script at the statement following the **Call**.

Syntax

```
Call ScriptName ;
```

ScriptName is the name of the script to call.

Remarks

The case of the script name must be the same as in the script definition.

A called script need not be part of the same macro as the calling object. However, the names of all loaded objects must be unique.

See Also

Return.

Example

```
Object Message is Script;  
  Msg (INF01, "Example", "Message script");  
EndObject Message.
```

```
Object Caller is Script;  
  Call Message;  
  Msg (INF01, "Example", "Caller script");  
EndObject Caller.
```

The Caller script uses the **Call** statement to branch to the Message script. This displays a message box and then returns to the Caller script, which displays a second message.

CapsLock

Sets the keyboard caps lock on or off.

Syntax

```
CapsLock( [ On | Off ] ) ;
```

On Sets the caps lock on.

Off Sets the caps lock off.

See Also

NumLock.

Example

```
CapsLock(On) ;
```

Sets the caps lock on.

Connect

Establishes a connection to a host, using either a specified configuration file, or that which is currently loaded.

Syntax

```
Connect(Config$) ;
```

```
On Connect(Config$) Goto Label {, Label {...}} ;
```

```
On Connect() Goto Label {, Label {...}} ;
```

Remarks

In the first two forms of the command, *Config*\$ must be the full path name of a RealLink configuration file enclosed in double quotes. If you supply a null string (""), instead of the name of a configuration file, the Connect dialog box is displayed for the user to select a configuration file. Note that if there is a connection already open, it is disconnected.

The second form of the command allows you to take different actions, depending on whether or not the connection was successful.

The third form of the command tests whether a connection is already open. If not, it attempts to connect using the currently loaded configuration file.

Return Values

- 0 The connection failed for reasons other than specified in 2 below.
- 1 Connection was established successfully, or was already open.
- 2 The configuration file could not be found or is invalid.

See Also

Disconnect, On...Goto.

Examples

```
On Connect("C:\RFW\ACCOUNTS.CFG") Goto fail, connected;
```

Attempts a connection using the configuration file "C:\RFW\ACCOUNTS.CFG". If successful, the script branches to the label "connected". If the connection fails, the script branches instead to the label "fail".

```
On Connect("") Goto fail, connected;
```

Displays the Connect dialog box for the user to select a configuration file. If the user clicks OK, a connection is attempted using the selected configuration file. If successful, the script branches to the label "connected". If the connection fails, the script branches instead to the label "fail".

```
On Connect() Goto fail, connected;
```

Tests for an existing connection. If there is none, attempts to connect using the currently loaded configuration file. If, on return, a connection exists, the script branches to the label "connected"; otherwise it branches to "fail".

Define

This command allows you to create a new **MenuItem** or **Button** object, to change the appearance or function of an existing menu or button object, or to move an object from one parent object to another.

Syntax

```
Define Object { In Parent } { String$ } { [ Do | = ] Instruction } ;
```

Object This must be the name of a **MenuItem** or **Button** object to be created or modified, or of a **PulldownMenu** or **Menu** object to be modified. If the object already exists, it will be modified as specified.

A newly created object will be of the type appropriate to the parent specified - if *Parent* specifies a **PopupMenu**, **PulldownMenu**, or **Menu**, a new **MenuItem** object will be created; similarly, if *Parent* specifies a **Toolbar**, a new **Button** object will be created.

When attaching an existing object to a new parent, the object must be of the type appropriate to its new parent - if *Parent* specifies a **PopupMenu**, **PulldownMenu**, or **Menu**, *Object* must be a **MenuItem**; similarly, if *Parent* specifies a **Toolbar**, *Object* must be a **Button**.

Parent This optional parameter is the name of an existing toolbar or menu. Note that this parameter is only necessary when creating a new object or attaching an object to a new parent.

String\$ This can be either the text to appear on the button or menu, or the name of a bitmap (.BMP), icon (.ICO), program (.EXE) or Dynamic Link Library (.DLL) file containing a graphic to display on the button. Unless you specify the path name of the file in full, it is assumed to be in the directory specified by the Bitmaps entry in the RealLink section of the RFW.INI file. In the case of icon, program and DLL files containing more than one icon, the first one will be used.

Instruction This must be one of the following macro commands:

| | | |
|----------|--------|----------|
| Call | Draw | Maximise |
| CapsLock | Enable | Minimise |
| Connect | Exec | NumLock |
| Define | Exit | SendLine |
| Disable | Load | SendText |

Remarks

If you are creating a new object and do not specify a parent, the type of object (button or menu item) is not determined until you add it to a menu or toolbar.

See Also

Toolbar object, **PulldownMenu object**, **PopupMenu object**.

Examples

```
Define mitLogoff In pdnHost "&Log off" Do SendLine("OFF");
```

Creates a new object menu item called mitLogoff and attaches it to the menu pdnHost. The new item will have the title "Log off" with "L" as its selector key, and will send the command "OFF" to the host.

```
Define btnStats "Statistics" Do Call scrStats;
```

Redefines the btnStats button to have the title "Statistics" and call the scrStats script.

```
Define pdnHost "&Host";
```

Defines a new title for the pull-down menu pdnHost.

Delay

Pauses execution of the script.

Syntax

```
Delay(Wait) ;
```

Wait is the time to wait, in seconds.

See Also

WaitFor.

Example

```
Object MinWin is Script;  
  Minimise;  
  Delay(5);  
  Restore;  
EndObject MinWin.
```

Minimises the ReaLink window, waits 5 seconds and then restores it to its previous position and size.

Disable

Disables the specified object. When disabled, the object will not react to mouse clicks or key-presses as appropriate.

Syntax

```
Disable(Object) ;
```

Object must be the name of the macro object to be disabled. Note that you cannot disable a Script object.

See Also

Enable, Object...EndObject.

Example

```
Disable(Top)
```

Disables the object called 'Top'.

Disconnect

Pauses the script until the current session has been disconnected.

Syntax

```
On Disconnect() Goto Label {, Label {...}} ;
```

Return Value

When disconnection occurs, one of the following values is returned:

- 0 The user has closed Reallink.
- 1 The user has disconnected the session with the Disconnect command.
- 2 The connection has failed.
- 3 The host has disconnected. This might be because the user has logged off.

Note that other scripts can be run from a toolbar while a script is waiting for disconnection.

See Also

Connect, On...Goto.

Example

```
Object Disconn is Script;  
  On Disconnect() Goto exit, exit, fail;  
  
  Msg(INF01, "Example", "Host has disconnected");  
  Return;  
  
fail:  
  Msg(INF01, "Example", "Host connection failed");  
  
exit:  
  Return;  
EndObject Disconn.
```

This script waits for disconnection and, if this occurs within Reallink, simply returns. If, however, the host has disconnected or the connection has failed, it displays an appropriate message before returning.

Draw

Draws a pop-up menu at the current position of the mouse pointer.

Syntax

```
Draw(PopupMenu) ;
```

PopupMenu must be the name of a **PopupMenu** object.

See Also

PopupMenu object.

Example

```
Object Popup is PopupMenu ;
  Popup1 Is MenuItem "Action 1" Do Call Action1 ;
  Popup2 Is MenuItem "Action 2" Do Call Action2 ;
EndObject Popup.
```

```
Object Mouse Is Mouseactions;
  Ctrl+Click, Button3 Do Draw(Popup) ;
EndObject Mouse.
```

In this example, two objects are defined: a **PopupMenu** called **Popup** and a **Mouseactions** object called **Mouse** (the scripts **Action1** and **Action2** are assumed to have been defined elsewhere). The **Mouseactions** object defines an action for the combination of button 3 and the CTRL key - it uses the **Draw** command to display the pop-up menu.

Enable

Enables the specified macro object. If the object was previously disabled, it will once again react to mouse clicks or key-presses as appropriate.

Syntax

```
Enable(Object) ;
```

Object must be the name of the macro object to be disabled.

See Also

Disable, Object...EndObject.

Example

```
Enable(Top)
```

Enables the object called 'Top'.

Exec

Starts another program under Microsoft Windows.

Syntax

```
Exec(Program$) ;
```

Program\$ must be the exact name of the program file, including the extension and path required to find the file, together with any switches or arguments that the program accepts, all enclosed in double quotes.

Examples

```
Exec("EXCEL.EXE");
```

Starts Microsoft Excel.

```
Exec("C:\WINWORD\WINWORD.EXE REPORT.DOC");
```

Starts Microsoft Word for Windows and loads the document REPORT.DOC.

Exit

```
Exec("NOTEPAD.EXE NOTES.TXT");
```

Starts Notepad and loads the document NOTES.TXT.

Exit

This command closes ReaLink.

Syntax

```
Exit ;
```

Remarks

Calling the **Exit** command may generate prompts that require responses from the user. Refer to Chapter 4 for details.

FIRST

Defines a script that will be executed automatically when the macro file is loaded.

Syntax

```
Object FIRST Is Script ;  
    Instruction ;  
    { ... }  
EndObject FIRST .
```

See Also

Script object.

Example

```
Object FIRST is Script;  
    Connect("C:\RFW\ACCOUNTS.CFG");  
    Return;  
EndObject FIRST.
```

This script attempts to connect to the host specified in the file ACCOUNTS.CFG. Because the script is called **FIRST**, it will be executed automatically when the macro file is loaded.

Goto

Branches unconditionally to a line identified by a label.

Syntax

```
Goto Label ;
```

Caution

Label must be a label that occurs elsewhere in the same script. If the label cannot be found the script will continue without branching.

See Also

On...Goto.

Example

```
Object Branches is Script;
  On Msg(ALERT, "Example", "Stop - press a button",
    "Button 1", "Button 2") Goto B1, B2;

B1:
  Msg(INFO1,"Example", "Button 1 pressed");
  Goto End;

B2:
  Msg(INFO1,"Example", "Button 2 pressed");

End:
  Return;
EndObject Branches.
```

This script displays a message, asking the user to choose between two buttons. When the user makes a choice, the script branches to a label and displays a second message. In the case of button 1, the **Goto** statement causes the script to branch to the End: label, thus preventing the button 2 message being displayed as well as that for button 1.

Hide

Hides the Reallink window.

Warning

When the Reallink window is hidden, it cannot be accessed by the user. If you use this command, you *must* ensure that your macro shows the window again.

Syntax

Hide ;

See Also

Show.

Example

```
Object HideWin is Script;
  Msg(INFO1, "Example", "Hide RFW for 5 seconds");
  Hide;
  Delay(5);
  Show;
  Return;
EndObject HideWin.
```

This example hides the Reallink window and then, 5 seconds later, displays it again.

InputText

Displays a dialog box requesting a single item of data, and when the user clicks OK, sends the text entered to the host.

Syntax

```
InputText(Prompt$ {, Default$ {, Title$ }) ;
```

Prompt\$ is text that will be displayed in the dialog box to indicate the kind of information that should be entered.

Default\$ is text that will initially appear in the entry field of the dialog box. This text is sent to the host if the user chooses OK without first typing anything.

Title\$ is the title displayed in the title bar of the dialog box; if *Title\$* is omitted, the title bar remains blank.

Return Value

If the user clicks the OK button or presses RETURN, the text entered is sent to the host and **InputText** returns 1. If the user clicks the Cancel button or presses the ESC key, nothing is sent to the host and **InputText** returns 0.

Remarks

The text entered is sent to the host without a terminating carriage return.

See Also

Password, SendLine, SendText.

Example

```
SendText("SORT GUESTS BY ARRIVAL-DATE WITH ARRIVAL-DATE GE /22");  
InputText("Enter the starting date:", "", "Guests");  
SendText("/22 AND LE /22");  
InputText("Enter the finishing date:", "", "Guests");  
SendLine("/22");
```

This example constructs an English query that lists the guests due to arrive at a hotel. The **InputText** command is used to prompt for starting and finishing dates for the report. Note the characters specified in hexadecimal ("/22"): these are the double quotation marks that must enclose the dates when they are used in the English statement (refer to page 8-109 for more details).

Keyactions Object

Assigns actions to the keyboard function keys.

Syntax

```
Object Name Is Keyactions;  
    KeyDefinition ;  
    { ... }  
EndObject Name.
```

Name must be a unique name for the object.

Key Definitions

Each key definition must have the following format:

Key = *Instruction* ;

Key This is the name of a function key (F1 to F15). If required, the function key can be combined by plus signs with one or more of the following modifier keys:

| | | |
|-------|------|-----|
| Shift | Ctrl | Alt |
|-------|------|-----|

Instruction This must be one of the following macro commands:

| | | |
|----------|--------|----------|
| Call | Draw | Maximise |
| CapsLock | Enable | Minimise |
| Connect | Exec | NumLock |
| Define | Exit | SendLine |
| Disable | Load | SendText |

Each key definition must be terminated with a semicolon.

Remarks

The object name must have the same case in the **Object** and **EndObject** statements.

Only one **Keyactions** object can be active at a time. If you load a macro that defines a new **Keyactions** object, the previous one will be disabled until the new macro is unloaded.

See also

Mouseactions object, **PopupMenu** object, **PulldownMenu** object, **Toolbar** object.

Example

```
Object KeyTable is Keyactions ;
  Ctrl + Shift + F12 = SendText("Control+Shift+F12");
  Shift + F12 = Exec("notepad");
EndObject KeyTable.
```

This example defines two key actions. When the user presses CTRL+SHIFT+F12, the text "Control+Shift+F12" will be sent to the host. Similarly, when the user presses SHIFT+F12, the Windows Notepad utility will be started.

Load

Loads a macro file into ReaLink.

Syntax

Load(*MacroFile*\$) ;

MacroFile\$ is the name of a macro file. Unless you specify the path name of the file in full, it is assumed to be in the directory specified by the **MacroDir** entry in the ReaLink section of the RFW.INI file.

Remarks

If the macro contains a script called FIRST, this will be executed automatically.

If you attempt to load a macro that is already loaded, the original copy will be removed before the new one is loaded.

Example

```
Load("C:\RFW\MACROS\ACCOUNTS.MAC")
```

This example loads the macro "ACCOUNTS.MAC" from the directory "C:\RFW\MACROS".

Maximise

Maximises the RealLink window - that is, expands it to fill the whole of the screen.

Syntax

```
Max{[imise | imize]} ;
```

See Also

Minimise, Restore.

Example

```
Object MaxWin is Script;  
  Maximise;  
  Delay(5);  
  Restore;  
EndObject MaxWin.
```

Maximises the RealLink window, waits 5 seconds and then restores it to its previous position and size.

Menu Object

Defines a cascaded menu (attached to another menu) containing commands that the user can select to run macro scripts or individual macro commands.

Syntax

```
{ MenuName Is } Menu Title$ {  
  MenuItemDefinition ;  
  { ... }  
};
```

MenuName This is an optional name for the menu. Specifying a name allows you to enable and disable an object (see **Enable** and **Disable** commands) and redefine it with the **Define** command.

Title\$ This is the text that will appear for that item on the parent menu.

You can designate one of the characters in the title as a selector key by preceding it with an ampersand (&). When the menu item is displayed, the character concerned is shown underlined and the user can select it by typing that character.

Each *MenuItemDefinition* can be the definition of a **Menuitem** object (see page 8-109) or of another **Menu** object.

Note: The braces (curly brackets) shown enclosing the menu item definitions are literal characters.

See also

Menuitem object, **PopupMenu** object, **PulldownMenu** object.

Examples

```
Object App Is PulldownMenu "&Application" ;
  App1 Is MenuItem "Action &1" Do Call Action1 ;
  App2 Is MenuItem "Action &2" Do Call Action2 ;
  MenuItem "-" ;
  App3 Is MenuItem "Action &3" Do Call Action3 ;
  MoreItems Is Menu "&More" {
    Cascade1 Is MenuItem "Action &4" Do Call Action4 ;
    Cascade2 Is MenuItem "Action &5" Do Call Action5 ;
  } ;
EndObject Application.
```

This example defines a **PulldownMenu** object called **App** with the title "Application". This menu includes a cascaded menu with the title "More", which contains "Action 4" and "Action 5" menu items. The letter "M" in the title is designated as the menu's selector key. The scripts **Action4** and **Action5** are assumed to have been defined elsewhere.

Menuitem Object

Defines a menu command that the user can choose to run a macro script or an individual macro command.

Syntax

```
{ ItemName Is } Menuitem Title$ [ Do | = ] Instruction ;
```

```
{ ItemName Is } Menuitem "-" ;
```

ItemName This is an optional name for the menu item. Specifying a name allows you to enable and disable an object (see **Enable** and **Disable** commands) and redefine it with the **Define** command.

Title\$ This is the text that will appear for that item on the parent menu.

You can designate one of the characters in the title as a selector key by preceding it with an ampersand (&). When the menu item is displayed, the character concerned is shown underlined and the user can select it by typing that character.

If a single hyphen is used as the title of a menu item, a separator item is created. This appears as a continuous line across the width of its parent menu. A separator item cannot be selected by the user and should be used to visually group related menu items.

Instruction This must be one of the following macro commands:

| | | |
|----------|--------|----------|
| Call | Draw | Maximise |
| CapsLock | Enable | Minimise |
| Connect | Exec | NumLock |
| Define | Exit | SendLine |
| Disable | Load | SendText |

See also

Menu object, PopupMenu object, PulldownMenu object.

Example

```
Object App Is PulldownMenu "&Application" ;
  App1 Is MenuItem "Action &1" Do Call Action1 ;
  App2 Is MenuItem "Action &2" Do Call Action2 ;
  MenuItem "-" ;
  App3 Is MenuItem "Action &3" Do Call Action3 ;
  MoreItems Is Menu "&More" {
    Cascade1 Is MenuItem "Action &4" Do Call Action4 ;
    Cascade2 Is MenuItem "Action &5" Do Call Action5 ;
  } ;
EndObject Application.
```

This example defines a **PulldownMenu** object called App with the title "Application". The letter "A" in the title is designated as the menu's selector key.

The menu contains three **MenuItem** objects, with the titles "Action 1" to "Action 3", and a separator item between "Action 2" and "Action 3". There is also a cascaded menu with the title "More", which contains "Action 4" and "Action 5" menu items. The scripts Action1 to Action5 are assumed to have been defined elsewhere.

Minimise

Minimises the RealLink window - that is, reduces it to an icon at the bottom of the screen.

Syntax

```
Min{[imise | imize]} ;
```

See also

Maximise, Restore.

Example

```
Object MinWin is Script;
  Minimise;
  Delay(5);
  Restore;
EndObject MinWin.
```

Minimises the RealLink window, waits 5 seconds and then restores it to its previous position and size.

Mouseactions Object

Assigns actions to the mouse buttons.

Syntax

```
Object Name Is Mouseactions;
    ButtonDefinition ;
    { ... }
EndObject Name.
```

Name must be a unique name for the object.

Button Definitions

Each button definition must have the following format:

```
{ KeyMods + } [ Click | DbIClick ] , Button [ Do | = ] Instruction ;
```

KeyMods This is one or more of the following modifier keys, combined, if necessary, by plus signs.

| | | |
|-------|------|-----|
| Shift | Ctrl | Alt |
|-------|------|-----|

Button This can be either the number of the required mouse button (1, 2 or 3) or the keyword **Button** followed, without a space, by the button number (for example, **Button3**). Buttons 1 and 3 are normally the primary and secondary mouse buttons respectively (the primary button is normally on the left of the mouse, and the secondary on the right, but left-handed users can use the Control Panel to swap them if required). Button 2 specifies the centre button on a three button mouse.

To avoid conflicts with RealLink mouse actions, button 1 must always be combined with one or more modifier keys. Button 3 can be used without modifier keys, but doing so will disable some RealLink functions.

Instruction This must be one of the following macro commands:

| | | |
|----------|--------|----------|
| Call | Draw | Maximise |
| CapsLock | Enable | Minimise |
| Connect | Exec | NumLock |
| Define | Exit | SendLine |
| Disable | Load | SendText |

Each button definition must be terminated with a semicolon.

Remarks

The object name must have the same case in the **Object** and **EndObject** statements.

Only one **Mouseactions** object can be active at a time. If you load a macro that defines a new **Mouseactions** object, the previous one will be disabled until the new macro is unloaded.

See also

Keyactions object, PopupMenu object, PulldownMenu object, Toolbar object.

Example

```
Object Popup is PopupMenu ;
  Popup1 Is MenuItem "Action 1" Do Call Action1 ;
  Popup2 Is MenuItem "Action 2" Do Call Action2 ;
EndObject Popup.

Object Mouse Is Mouseactions;
  Ctrl+Click, Button3 Do Draw(Popup) ;
EndObject Mouse.
```

In this example, two objects are defined: a **PopupMenu** called **Popup** and a **Mouseactions** object called **Mouse** (the scripts **Action1** and **Action2** are assumed to have been defined elsewhere). The **Mouseactions** object defines an action for the combination of button 3 and the CTRL key - it uses the **Draw** command to display the pop-up menu.

Msg

Displays a message box.

Syntax











```
Msg(Style, Title$, Message$) ;
```

```
On Msg(Style, Title$, Message${, Caption1${, Caption2$ {...}}}) Goto Label1
  {, Label2 {...}} ;
```

Syntax Elements

Style must be one of the styles listed in Table 8-1.

Table 8-1. Message Box Styles

| Style | Appearance | Icon |
|--------|---|---|
| INFO | Information icon and user defined buttons. |  |
| INFO1 | Information icon and single OK button. |  |
| WARN | Warning icon and user defined buttons. |  |
| WARN2 | Warning icon; OK and Cancel buttons |  |
| WARN3 | Warning icon; Yes, No and Cancel buttons |  |
| ALERT | Alert icon and user defined buttons. |  |
| ALERT2 | Alert icon; Retry and Cancel buttons |  |
| ALERT3 | Alert icon; Abort, Retry and Ignore buttons |  |
| QUERY | Query icon and user defined buttons. |  |
| QUERY2 | Query icon; OK and Cancel buttons |  |
| QUERY3 | Query icon; Yes, No and Cancel buttons |  |

The **INFO**, **WARN**, **ALERT** and **QUERY** styles allow you to specify the number and captions of the buttons. See below.

Title\$ is the title to appear on the message box.

Message\$ is the message that will be displayed. A newline character - `"/0A"` - can be used to start a new line where required.

Caption1\$, *Caption2*\$ are the captions to appear on the buttons. The number of buttons depends on the number of caption strings, up to a maximum of three.

Note: The left-most button is always the default.

Return Value

The `Msg` command returns the number of the button that was clicked by the user: 0 for the first button, 1 for the second button, etc. This can be used in the `On...Goto` statement to branch to different parts of the script, depending on which button was clicked. Note, however, that because of this, the first form of the command should only be used for message boxes with a single button, as there is no way of detecting which button was clicked.

See Also

Input Text, Password.

Examples

```
Msg(INFO1, "Example", "This is a message");
```

Displays a message box with an information icon and a single OK button.

```
On Msg(ALERT2, "Example", "Connection failed") Goto retry, cancel;
```

Displays a message box with an Alert icon, and Retry and Cancel buttons. When the user responds, the script branches to the retry or cancel label as appropriate.

```
On Msg(QUERY, "Example", "Macro paused", "Continue", "Quit") Goto  
continue, quit;
```

Displays a message box with a Query icon, and two buttons: Continue and Quit. When the user responds, the script branches to the continue or quit label as appropriate.

NumLock

Sets the keypad number lock on or off.

Syntax

```
NumLock( [ On | Off ] ) ;
```

On Sets the number lock on.

Off Sets the number lock off.

See Also

CapsLock.

Example

```
NumLock(Off);
```

Sets the number lock off.

Object...EndObject

Defines a RealLink macro object.

Syntax

```
Object Name Is Type { Options };  
    Instruction ;  
    { ... }  
EndObject Name .
```

Name is a user-defined identifier. Note that all macro names must be unique - this is particularly important when more than one macro file is loaded.

Type must be one of the following object types: **Keyactions**, **Menu**, **Mouseactions**, **PopupMenu**, **PulldownMenu**, **Script** or **Toolbar**.

Options is one or more object-dependent optional parameters. See the descriptions of the different object types for details of these parameters.

See also

FIRST, **Keyactions object**, **Mouseactions object**, **PopupMenu object**, **PulldownMenu object**, **Script object**, **Toolbar object**.

On...Goto

Branches to one of a number of lines specified by labels.

Syntax

```
On Expression Goto Label {, Label {...}} ;
```

Remarks

The *Expression* parameter must be one of the following functions:

- Call
- Connect
- Disconnect
- Msg
- WaitFor

The value of *Expression* determines to which label the script branches. For example, if *Expression* returns 0, the script will branch to the first label in the list. Similarly, if *Expression* returns 2, the script will branch to the third label in the list. If the value returned by expression does not have a corresponding label, the script continues without branching.

Caution

Each of the labels must occur elsewhere in the same script. If a label cannot be found the script will continue without branching.

See also

Goto, Script object, Return.

Example

```

Object Branches is Script;
  On Msg(ALERT, "Example", "Stop - press a button",
    "Button 1", "Button 2", "Button 3") Goto B1, B2;

  Msg(INFO1,"Example", "Button 3 pressed");
  Goto End;

B1:
  Msg(INFO1,"Example", "Button 1 pressed");
  Goto End;

B2:
  Msg(INFO1,"Example", "Button 2 pressed");

End:
  Return;
EndObject Branches.

```

This script displays a message, asking the user to choose between two buttons. When the user makes a choice, the script branches to a label and displays a second message. Note, however, that in the case of button 3, there is no associated label, so the script does not branch.

Password

Displays a dialog box that prompts the user for a password. The text entered by the user is not displayed in the dialog, but is replaced by asterisks. When the user clicks the OK button or presses RETURN, the text is sent to the host.

Syntax

```
Password(Prompt$ {, Default$ {, Title$ }) ;
```

Syntax Elements

| | |
|------------------|--|
| <i>Prompt\$</i> | is a text string to be displayed in the dialog box. |
| <i>Default\$</i> | is text (replaced by asterisks) that will initially appear in the entry field of the dialog box. This text is sent to the host if the user chooses OK without first typing anything. |
| <i>Title\$</i> | is the text to be displayed in the title bar of the dialog box. If no title is specified, the title "Password" is displayed. |

Return Value

If the user clicks the OK button or presses RETURN, the text entered is sent to the host and **Password** returns 1. If the user clicks the Cancel button or presses the ESC key, nothing is sent to the host and **Password** returns 0.

The text entered is sent to the host without a terminating carriage return.

Remarks

You should normally use the **Password** command in conjunction with the **WaitFor** command. Use **WaitFor** to detect the host's password prompt, and then use **Password** to prompt the user for the password.

See also

InputText, **SendLine**, **SendText**.

Example

```
Object Reality is Script;
  // set the WaitFor timeout
  Timeout(5);

  On Connect("C:\RFW\ACCOUNTS.CFG") Goto fail;

  // user logon
  SendLine("");
  On WaitFor("LOGON PLEASE:") goto fail;
  SendLine("PAULSH");
  On WaitFor("Password:") goto fail;
  Password("Please enter your password:", "", "Payroll system");
  SendLine("");
  Return;

fail:
  Msg(INF01,"Reality", "Logon to Reality failed");
  Return;
EndObject Reality.
```

Connects and logs on to the host defined in the ACCOUNTS.CFG configuration file. The script waits for the host to prompt for a password, and then displays a Password dialog box.

PopupMenu and PulldownMenu Objects

These commands define menus containing commands that the user can select to run macro scripts and individual macro commands.

A pull-down menu appears on the menu bar beside the normal Reallink menus.

A pop-up menu is not attached to the menu bar or another menu and is not available to the user until it is displayed with the **Draw** command.

Syntax

```
Object Name Is PopupMenu ;
  MenuItemDefinition ;
  { ... }
EndObject Name .
```

```
Object Name Is [ PulldownMenu | Menu ] Title$;
  MenuItemDefinition ;
  { ... }
EndObject Name .
```

| | |
|-----------------|---|
| <i>Name</i> | This must be a unique name for the menu object. |
| <i>Title</i> \$ | This is the text that will appear on the RealLink menu bar. You can designate one of the characters in the title as a selector key by preceding it with an ampersand (&). When the menu title is displayed on the menu bar, the character concerned is shown underlined. The user can select the menu by pressing the ALT key, followed by the selector key. |

MenuItemDefinition is one or more **Menu** or **MenuItem** object definitions (see pages 8-108 and 8-109 respectively).

Remarks

The object name must have the same case in the **Object** and **EndObject** statements.

See also

Draw, **Keyactions** object, **Menu** object, **MenuItem** object, **Mouseactions** object, **Toolbar** object.

Examples

```
Object Popup Is PopupMenu ;
  Popup1 Is MenuItem "Action 1" Do Call Action1 ;
  Popup2 Is MenuItem "Action 2" Do Call Action2 ;
EndObject Popup.
```

```
Object Mouse Is Mouseactions;
  Ctrl+Click, Button3 Do Draw(Popup) ;
EndObject Mouse.
```

In this example, two objects are defined: a **PopupMenu** called **Popup** and a **Mouseactions** object called **Mouse** (the scripts **Action1** and **Action2** are assumed to have been defined elsewhere). The **Mouseactions** object defines an action for the combination of button 3 and the CTRL key - it uses the **Draw** command to display the pop-up menu.

```
Object App Is PulldownMenu "&Application" ;
  App1 Is MenuItem "Action &1" Do Call Action1 ;
  App2 Is MenuItem "Action &2" Do Call Action2 ;
  MenuItem "-" ;
  App3 Is MenuItem "Action &3" Do Call Action3 ;
  MoreItems Is Menu "&More" {
    Cascade1 Is MenuItem "Action &4" Do Call Action4 ;
    Cascade2 Is MenuItem "Action &5" Do Call Action5 ;
  } ;
EndObject Application.
```

This example defines a **PulldownMenu** object called **App** with the title "Application". The letter "A" in the title is designated as the menu's selector key.

The menu contains three **MenuItem** objects, with the titles "Action 1" to "Action 3", and a separator item between "Action 2" and "Action 3". There is also a cascaded menu with the title "More", which contains "Action 4" and "Action 5" menu items. The scripts **Action1** to **Action5** are assumed to have been defined elsewhere.

Restore

If the ReaLink window is minimised or maximised, this command restores it to its previous size and position.

Syntax

```
Restore ;
```

See also

Maximise, Minimise.

Example

```
Object MinWin is Script;  
  Minimise;  
  Delay(5);  
  Restore;  
EndObject MinWin.
```

Minimises the ReaLink window, waits 5 seconds and then restores it to its previous position and size.

Return

Returns control from the current script to the calling script, if any, or to ReaLink if there is none.

Syntax

```
Return ;
```

```
Return(Value) ;
```

Value is an integer value to be returned to the calling script (if any). This value can be tested with the `On...Goto` statement.

See also

Call.

Examples

```
Object Branches is Script;  
  On Msg(ALERT, "Example", "Stop - press a button",  
    "Button 1", "Button 2") Goto B1, B2;  
  
B1:  
  Msg(INFO1,"Example", "Button 1 pressed");  
  Return;  
  
B2:  
  Msg(INFO1,"Example", "Button 2 pressed");  
  Return;  
EndObject Branches.
```

The above script displays a message, asking the user to choose between two buttons. When the user makes a choice, the script branches to a label and displays a second message. In the case of button 1, after the second message has been displayed, the

Return statement causes the script to return to the calling script, thus preventing the button 2 message being displayed as well as that for button 1.

```

Object Choice is Script;
  On Msg(ALERT, "Example", "Stop - press a button", "Button 1",
"Button 2") Goto B1, B2;

B1:
  Return(1);

B2:
  Return(2);
EndObject Choice.

Object Branches is Script;
  On Choice Goto B1, B2;

B1:
  Msg(INFO1,"Example", "Button 1 pressed");
  Goto End;

B2:
  Msg(INFO1,"Example", "Button 2 pressed");

End:
  Return;
EndObject Branches.

```

In this example, the first script (Choice) displays a message, asking the user to choose between two buttons. When the user makes a choice, the script branches to a label and returns a value representing the button that was pressed. The second script calls the Choice script and, depending on the value returned, branches to one of two labels and displays an appropriate message.

Script Object

Defines a macro script.

Syntax

```

Object Name is Script ;
  Instruction ;
  { ... }
EndObject Name .

```

Name is the name of the script.

Remarks

The names of all loaded objects must be unique.

The script name must have the same case in the **Object** and **EndObject** statements.

Each instruction in a script must be terminated with a semicolon.

A script can be assigned to a function key, mouse button, menu item or toolbar button, or called from another script. If you give a script the name **FIRST**, it will be executed automatically when the macro is loaded.

See also

Button object, Keyactions object, Menu object, MenuItem object, Mouseactions object, PopupMenu object, PulldownMenu object, Toolbar object.

Example

```
Object Accounts is Script;  
    Connect("C:\RFW\ACCOUNTS.CFG");  
    Return;  
EndObject Accounts.
```

This script attempts to connect to the host specified in the file ACCOUNTS.CFG.

SendLine

Sends a text string to the connected host and appends a carriage return character.

Syntax

```
SendLine(String);
```

String is the text to be sent, enclosed in double quotes.

Remarks

Control characters can be included in the text if required - see page 8-109 for details.

See also

SendText, InputText, Password.

Example

```
Object Reality is Script;  
    // set the WaitFor timeout  
    Timeout(5);  
  
    On Connect("C:\RFW\ACCOUNTS.CFG") Goto fail;  
  
    // user logon  
    SendLine("");  
    On WaitFor("LOGON PLEASE:") goto fail;  
    SendLine("PAULSH");  
    On WaitFor("assword:") goto fail;  
    Password("Reality Password");  
    Sendline("");  
    Return;  
  
fail:  
    Msg(1,"Reality", "Logon to Reality failed");  
    Return;  
EndObject Reality.
```

Connects and logs on to the host defined in the ACCOUNTS.CFG configuration file. The script waits for the host to display the "LOGON PLEASE:" prompt, and then sends the text "PAULSH".

SendText

Sends a text string to the connected host.

Syntax

```
SendText(String$) ;
```

String\$ is the text to be sent, enclosed in double quotes.

Remarks

Control characters can be included in the text if required - see page 8-109 for details.

See also

SendLine, InputText, Password.

Example

```
Object Reality is Script;
  // set the WaitFor timeout
  Timeout(5);

  On Connect("C:\RFW\ACCOUNTS.CFG") Goto fail;

  // user logon
  SendLine("");
  On WaitFor("LOGON PLEASE:") goto fail;
  SendText("PAULSH/OD");
  On WaitFor("assword:") goto fail;
  Password("Reality Password");
  Sendline("");
  Return;

fail:
  Msg(1,"Reality", "Logon to Reality failed");
  Return;
EndObject Reality.
```

Connects and logs on to the host defined in the ACCOUNTS.CFG configuration file. The script waits for the host to display the "LOGON PLEASE:" prompt, and then sends the text "PAULSH" followed by a carriage return.

Show

If the RealLink window is hidden, this command displays it again.

Syntax

```
Show ;
```

See also

Hide.

Example

```
Object HideWin is Script;
  Msg(INFO1, "Example", "Hide RFW for 5 seconds");
  Hide;
  Delay(5);
```

```
Show;  
Return;  
EndObject HideWin.
```

This example hides the RealLink window and then, 5 seconds later, displays it again.

Space

This command generates space between two adjacent toolbar buttons. It can only be used in the definition of a **ToolBar** object.

Syntax

```
Space(Count) ;
```

Count is the amount of space to add between the buttons, in pixels.

See Also

ToolBar object.

Example

```
Object Top is ToolBar Above Recessed;  
  // text buttons  
  "Reality" = Call Reality;  
  "Unix" = Call Unix;  
  
  Space(10);  
  
  // bitmap buttons  
  "vcrplay.bmp" = SendLine("play");  
  "vcrstop.bmp" = Call Stop;  
  "vcrpause.bmp" = SendLine("pause");  
  "vcrend.bmp" = SendLine("end");  
EndObject Top.
```

In this example the space between the second and third buttons is increased by 10 pixels.

Timeout

This command sets the time that the **WaitFor** command will wait for a response from the host before returning.

Syntax

```
Timeout(Wait) ;
```

Wait is the length of time to wait in seconds.

Remarks

The **WaitFor** timeout affects all macros and scripts in the current instance of RealLink.

If you do not set the timeout, the **WaitFor** command will wait for 20 seconds.

If you set the timeout to 0, the **WaitFor** command will never timeout.

See Also

`WaitFor`.

Example

```
Timeout(5);
```

Sets the `WaitFor` timeout to 5 seconds.

Toolbar Object

Defines a toolbar containing buttons that the user can click to run macro scripts or execute single macro commands.

Syntax

```
Object Name is Toolbar {Position} {Style};  
    ButtonDefinition ;  
    { ... }  
EndObject Name .
```

Name must be a unique name for the object.

Position

The *Position* parameter can be either of the following keywords:

| | |
|--------------|---|
| Above | Display the toolbar at the top of the RealLink window, just below the menu bar. |
| Below | Display the toolbar at the bottom of the RealLink window, just below the status bar (if displayed). |

If the *Position* parameter is omitted, the **Below** position is used.

Style

The *Style* parameter can be any one of the following keywords:

| | |
|-----------------|--|
| Plain | The toolbar will not be recessed or raised. There will be a small space between the buttons and the edge of the Toolbar. |
| Recessed | The toolbar will appear to be recessed slightly into the RealLink window. There will be a small space between the buttons and the edge of the Toolbar. |
| Raised | The toolbar will appear to be raised slightly above the surface of the RealLink window. There will be a small space between the buttons and the edge of the Toolbar. |
| None | The toolbar will not be recessed or raised. There will be no space between the buttons and the edge of the Toolbar. |

If the *Position* parameter is omitted, the **None** style is used.

Note that the space between adjacent buttons can be increased by using the **Space** command.

Button Definitions

ButtonDefinition is a **Button** object definition (see page 8-97).

Remarks

The object name must have the same case in the **Object** and **EndObject** statements.

Caution

Only two **ToolBar** objects can be active at a time: one at the top of the RealLink window, and the other at the bottom. If you load a macro that defines a new **ToolBar** object in a position already occupied by a toolbar from another macro, the previous macro will be unloaded, making its objects no longer available.

See also

Button object, **Keyactions** object, **Mouseactions** object, **PopupMenu** object, **PulldownMenu** object, **Space**.

Example

```
Object Top is ToolBar Above Recessed;
  // text buttons
  "Reality" = Call Reality;
  "Unix" = Call Unix;

  Space(10);

  // bitmap buttons
  "vcrplay.bmp" = SendLine("play");
  "vcrstop.bmp" = Call Stop;
  "vcrpause.bmp" = SendLine("pause");
  "vcrend.bmp" = SendLine("end");
EndObject Top.
```

This example defines a recessed toolbar that will be displayed at the top of the RealLink window. The first two buttons will have the text labels "Reality" and "Unix". There will then be a 10 pixel gap before a group of four buttons, each with a graphic icon.

Update

The **Update** statement controls most RealLink display changes while a macro is running. When screen updating is turned off, RealLink still allows the macro to display or retrieve information using the **InputText**, **Msg** and **Password** statements. You can increase the speed of some macros by preventing screen updates.

Warning

RealLink does not provide a menu command to restore screen updating. If you disable screen updating, you *must* ensure that your script restores updating before terminating.

Syntax

```
Update [ Off | On ] ;
```

- On** Switches screen updates on. The screen updates normally while the macro is running.
- Off** Disables screen updates. The screen does not update while the macro is running.

Example

```
Object Reality is Script;
  // Disable screen updating
  Update Off ;
  // set the WaitFor timeout
  Timeout(5);

  On Connect("C:\RFW\ACCOUNTS.CFG") Goto fail;

  // user logon
  SendLine("");
  On WaitFor("LOGON PLEASE:") goto fail;
  SendLine("PAULSH");
  On WaitFor("Password:") goto fail;
  Password("Please enter your password:", "", "Payroll system");
  Sendline("");
  Goto end;

fail:
  Msg(INF01,"Reality", "Logon to Reality failed");

end:
  // Re-enable screen updating
  Update On ;
  Return;
EndObject Reality.
```

This example disables screen updating while it connects to a host system. The **Password** command is unaffected by this and will display a dialog to request the user's password. The script restores screen updating on completion.

WaitFor

Waits for the host to display a specified text string.

Note: You should specify as long a text string as possible, to reduce the possibility of matching the wrong text.

Syntax

```
WaitFor(Text1{, Text2{...}}) ;
```

```
On WaitFor(Text1{, Text2{...}}) Goto Label {, Label{...}} ;
```

Text1{, *Text2*{, etc. are alternative text strings.

Return Value

The second form of **WaitFor** returns a value that represents which of the text strings was received from the host: 1 for the first string in the list, 2 for the second, etc. If the wait timeout (set by the **Timeout** command) is exceeded without any of the strings having been received, **WaitFor** returns 0.

See also

Delay, On...Goto, Timeout.

Example

```
Object Reality is Script;
  // set the Waitfor timeout
  Timeout(5);

  On Connect("C:\RFW\ACCOUNTS.CFG") Goto fail;

  // user logon
  SendLine("");
  On WaitFor("LOGON PLEASE:", "user id :") goto fail;
  SendText("PAULSH/OD");
  On WaitFor("assword:") goto fail;
  Password("Reality Password");
  Sendline("");
  Return;

fail:
  Msg(INFO1,"Reality", "Logon to Reality failed");
  Return;
EndObject Reality.
```

Connects and logs on to the host defined in the ACCOUNTS.CFG configuration file. The script waits for the host to prompt for a user id, and then sends the text "PAULSH" followed by a carriage return. It then waits for the host to prompt for a password and, when this occurs, displays a Password dialog box.

Reserved Words

The following lists the reserved words used by the RealLink Script Language:

| | | | |
|------------|-----------|--------------|----------|
| Above | Enable | InputText | QUERY |
| ALERT | EndObject | Is | QUERY2 |
| ALERT2 | Exec | Keyactions | QUERY3 |
| ALERT3 | Exit | Load | Raised |
| Alt | F1 | Max | Recessed |
| Below | F2 | Maximise | Restore |
| Button1 | F3 | Maximize | Return |
| Button2 | F4 | Menu | Script |
| Button3 | F5 | MenuItem | SendLine |
| Call | F6 | Min | SendText |
| CapsLock | F7 | Minimise | Shift |
| Click | F8 | Minimize | Show |
| Connect | F9 | Mouseactions | Space |
| Control | F10 | Msg | Timeout |
| Ctl | F11 | None | Toolbar |
| Ctrl | F12 | NumLock | Update |
| DbClick | F13 | Object | WaitFor |
| Define | F14 | Off | WARN |
| Delay | F15 | On | WARN2 |
| Disable | Goto | Password | WARN3 |
| Disconnect | Hide | Plain | |
| Do | INFO | PopupMenu | |
| Draw | INFO1 | PulldownMenu | |

Error Messages

Load-time Errors

The following errors can occur when loading a macro into RealLink:

An error has occurred in script file '*filename*' - Parse Status 1

This error indicates that the macro file has not been loaded. It will normally occur following another error.

Cannot open file - *filename*

The macro file *filename* cannot be found. Check the following:

- That the filename is correct.
- That the file extension is correct.
- That the correct drive and directory have been specified.
- That the correct drive and directory are specified in the MacroDir entry in RFW.INI (see Appendix A).

Error - Can only define Button 1 with Control or Shift: on line *nn*

In a **Mouseactions** object, you have attempted to define an action for the primary mouse button without any modifier keys (see page 8-111).

Error - identifier already exists: *object* on line *nn*

You have used an object identifier that is already in use by another object. If your macro normally loads successfully, check any macros that are already loaded.

Error - identifier mismatch : *object* on line *nn*

The object name *object* used in an **EndObject** statement does not match the name used in the corresponding **Object** statement.

parse error, expecting '*token1*' or '*token2*' ... or '*token5*' near token '*token6*' on line *nn*

The macro parser expected to find *token1* or *token2*, etc. but instead found *token6*.

parse error near token '*token*' on line *nn*

An unrecognised error has been found.

parser stack overflow

Contact your Northgate representative.

Run-time Errors

The following errors can occur when running a macro:

Call stack full

Your macro is too complex. Reduce the number of nested **Call**, **Disconnect** and **Waitfor** statements.

Tokens

The *token* parameters shown in the error messages listed above might be any of the reserved words listed on page 8-97, or one of the following:

| | |
|-------------------|---|
| COLON | The colon (:) that terminates a label definition. |
| EQUAL | The equals sign in a button or key definition. |
| IDENTIFIER | A label. |
| INTEGER | A number. |
| COMMA | A comma. |
| PERIOD | The full stop that terminates an EndObject statement. |
| SEMICOLON | The semicolon that terminates a command . |
| LPAR | The opening parenthesis that introduces a list of parameters. |
| PLUS | A plus sign (+) used in a key-combination definition. |
| RPAR | The closing parenthesis that terminates a list of parameters. |
| STRING | A literal string enclosed in double quotes. |

Chapter 9

Problem Solving

This chapter describes some of the more common operating problems encountered and suggests how they might be overcome.

Introduction

The types of problem are covered under the following headings:

- Problems running RealLink.
- Asynchronous communication problems.
- Problems with LAN sessions.
- File transfer problems

If you are unable to overcome the problem, you should contact your local support centre.

Problems Running RealLink

A blank page is ejected at the end of each printout

- If this occurs when you use Print Window or Print Selection, set the WindowPrintAppendFF entry in the [rfwprint.dll] section of the RFW.INI file to 0.
- If this occurs when you use the PORT-DESPOOL or PORTOUT TCL command, set the PrintAppendFF entry in the [rfwprint.dll] section of the RFW.INI file to 0.

The RFW.INI file is described in Appendix A.

Back-page does not work

The most obvious reason for this is that your configuration has no history pages specified. Check your terminal preferences (refer to Chapter 6 for details).

Double-clicking the RealLink Icon has no effect

- You have insufficient memory and/or system resources. Close down one or more applications and try again. If you have closed down all applications except the Windows Program Manager, and still cannot start RealLink, check that RealLink is installed correctly.
- If your PC beeps twice when you double-click the RealLink icon, the Country setting in the WIN.INI file may not match that of the RealLink message file. Refer to **Message - Cannot open message file**.
- If your PC beeps three times when you double-click the RealLink icon, your message file is out of date. Reinstall RealLink to obtain the correct message file.

Message - Cannot find font

You have not restarted Windows since installing RealLink, or the RealLink fonts were not installed properly.

1. Close down any applications and then return to DOS and restart Windows.
2. If this does not work, use the Control Panel to install the appropriate font. You will find the font files in the \WINDOWS\SYSTEM directory.
3. If you cannot find the font files, you will need to reinstall RealLink.

Message - Cannot open message file

If this message appears when you start RealLink, the Country setting in the WIN.INI file does not match that of the RealLink message file.

- If you have changed the country setting temporarily, return it to its original setting when you need to use RealLink.
- If you do not intend to restore the country to its previous setting, you must reinstall RealLink to obtain the correct message file.

Message – Cannot open the CFG file

- The CFG file you specified does not exist. Check that you typed its name correctly.
- You have run out of memory. Close down some applications and try again.

Message – Filename will be truncated Ok?

You have attempted to give a configuration file a name longer than 8 characters. If you click the OK button, the name will be truncated to the first eight characters. Click Cancel to return to the previous dialog and re-enter the file name.

Message – Illegal Filename: Device names cannot be used

You have attempted to give a configuration file the name of a DOS device. The following names cannot be used: CLOCK\$, CON, AUX, COM n (where $n = 1$ to 4), LPT n (where $n = 1$ to 3), NUL and PRN.

Printing does not work**The last page of each printout is not ejected**

- If either of these occurs when you use Print Window or Print Selection, set the WindowPrintAppendFF entry in the [rfwprint.dll] section of the RFW.INI file to 1.
- If either of these occurs when you use the PORT-DESPOOL or PORTOUT TCL command, set the PrintAppendFF entry in the [rfwprint.dll] section of the RFW.INI file to 1.

The RFW.INI file is described in Appendix A.

With the CAPS LOCK selected, the SHIFT key has no effect

Set the CapsShiftToggle entry in the [RealLink] section of the RFW.INI file to 1. The RFW.INI file is described in Appendix A.

Asynchronous Communication Problems

No response from the Host

- Communication might have been paused, either with the PAUSE key or CTRL+S. Press CTRL+Q to reverse the action of CTRL+S. If the host does not respond, try pressing PAUSE - the host should either respond, or the message "Press 'Pause' again to continue" will appear in the status bar. If the message appears, communication was not paused; press PAUSE again to restore the previous state.
- Check all cable connections.
- Ensure that the baud rate set in the CFG file is correct for the port to which you are attached.
- Ensure that the data word length, parity and stop bit settings in the CFG file are correct for the port.
- Ensure that the correct COM port has been selected in the CFG file.
- Ensure that the same method of flow control is being used on the PC and host.
- Ensure that the **Enable Callback Feature** option is not selected in the WINSNI.INI file. Refer to the *PCi Standard Network Interface Installation Guide* for details.

If all else fails, connect a standard terminal to the cable and note whether the problem persists. If it does you have a cable or connection problem, not a RealLink problem.

Garbled response from the Host

- Ensure that you are using the correct terminal emulation. Note that the default terminal emulation is ANSI 7-bit.
- Ensure that the baud rate selected in the CFG file is correct for the port to which you are attached.
- Ensure that the data word length, parity and stop bit settings selected are correct for the port.

Message: Hardware error or not present

- You have selected a port that is not installed on your PC.
- You have attempted to connect via a communications port that is already in use; for instance, by a serial mouse.

Check that you are using the correct communications port.

Message: Invalid System Name

You are attempting to use the Northgate LAN protocol for an asynchronous connection. Check that your communications parameters are correct.

Message: Invalid Stream

The name of the port you have specified is invalid. Check that your communications parameters are correct (see also "Problems with LAN Sessions").

Modem occasionally disconnects the Line

Some modems disconnect from the line if they detect that RealLink has dropped the DTR (Data Terminal Ready) signal for a few microseconds. Strap DTR high at the modem end so that the modem always sees the DTR signal.

Characters are occasionally lost

At high baud rates, the Windows asynchronous driver can sometimes lose characters. Find the [386Enh] section in the SYSTEM.INI file, and add the line:

```
COMnFIFO=1
```

where *n* is the number of the port you are using.

Note: Although this setting is in the [386Enh] section, it is also used when running Windows in Standard mode.

Problems with LAN Sessions

The majority of problems that you might encounter when using a LAN session are described in the *PCI Standard Network Interface Installation Guide*. However, you might also see the following messages:

Invalid Stream

You are attempting to use the Asynchronous Port protocol for a LAN connection. Check that your communications parameters are correct (see also "Asynchronous Communication Problems").

Network Error, DDA -> ACI replug

You are using LanFTU to transfer a file over a connection that uses the Telnet protocol.

- Check that you are using the correct connection.
- If the connection is correct, check that it uses the DDATCP protocol. Refer to the *PCI Standard Network Interface Installation Guide* for details of how to set the connection protocol.

Cannot find CCIDDA21.DLL
followed by
Unable to load CCIDDA21.DLL error 2

-or-

Cannot find CCITCP.DLL
followed by
Unable to load CCITCP.DLL error 2

If either of these pairs of messages appear, you are attempting to use a connection protocol that is no longer supported. Select the Communications command from the Setup menu. Then select the LAN protocol and click OK. Save your configuration file.

File Transfer Problems

The problems you might encounter when transferring files depend on the utility you are using.

LanFTU

Message: Record size too large

- When transferring data to a Sovereign file, a record has been found that is larger than that specified in the **Max Rec Size** field. Increase the maximum record size.
- When transferring data from a Sovereign file, a record has been found that is larger than the data transfer buffer on the PC. Set the BLOCKSIZE entry in the [WLANFTU] Section of RFW.INI to a larger value (refer to Appendix A for details).

Message: Stop - *DOSfile* contains no data

The length of the source DOS file is zero. Check that you have typed the DOS file name correctly.

Message: Stop - Can't find *DOSfile*

The source DOS file does not exist. Check that you have typed the DOS file name correctly.

Message: Unable to transfer data - error 20 (CONNECT)

LanFTU was unable to connect to the host. This message will normally be preceded by a network message that indicates the cause. These messages are described on page 9-106 and in the *PCI Standard Network Interface Installation Guide*.

Message: Unable to transfer data - error 54 (DOSOPEN)

The destination DOS file already exists and cannot be overwritten.

- Check that you have typed the file name correctly.
- Check that the file concerned is not read only.

Message: Unable to transfer data - error 55 (DISKWRITE)

An error occurred while writing to the destination DOS file. Use a disk maintenance program to check for and repair any disk errors.

Message: Unable to transfer data - error 60 (BINARY)

You have attempted to transfer a binary DOS file to the host, using an ASCII filter. Check your LanFTU settings.

Message: Unable to transfer data - error 61 (ROSOPEN)

The specified Reality file could not be opened. Check that you have typed the file name correctly.

Message: Warning - 0 bytes transferred to *DOSfile*

The source Reality item does not exist. Check that you have typed the item name correctly.

HOST-WS and WS-HOST

Message: COULDN'T OPEN FILE '*filename*'

The Reality file does not exist. Check that you have typed the file name correctly.

Message: COULDN'T READ ITEM '*itemname*' (HOST-WS)

The Reality item does not exist. Check that you have typed the item name correctly.

Message: COULDN'T READ ITEM 'RL.BP', '*filter*'

The filter you have specified does not exist. Check that you have typed the filter name correctly.

Message: INVALID FILTER ITEM

You have attempted to use a filter which cannot be used with HOST-WS or WS-HOST. Check that you have typed the filter name correctly.

Message: TRANSMISSION ERROR '*filename, itemname*'

HOST-WS:

- The DOS directory you have specified does not exist. Check that you have typed the DOS path and file name correctly.
- The DOS file already exists and is read only. Check that you have typed the DOS path and file name correctly. If you have, use the Windows File Manager to change the properties of the file.

WS-HOST:

- The DOS file you have specified does not exist. Check that you have typed the DOS path and file name correctly.

PASS-DOS and SPASS-DOS

Because these utilities use HOST-WS to transfer the converted data to the PC, many of the HOST-WS error messages are also applicable to PASS-DOS and SPASS-DOS. You might also see messages generated by TCL and English. The following are additional problems and error messages that apply specifically to the PASS-DOS and SPASS-DOS.

Message: CONVERSION FILTER NOT FOUND '*filter*'

- The filter you have specified does not exist. Check that you have typed the filter name correctly.
- You have included a FOOTING clause before the INTO clause. Reverse the order of these clauses.

Message: INVALID CONVERSION FILTER FORMAT '*filter*'

You have attempted to use a filter which cannot be used with PASS-DOS or SPASS-DOS.
Check that you have typed the filter name correctly.

No data is transferred

If no error messages appear, but no data is transferred, the most likely cause is that you have omitted the drive letter in the DOS file specification.

Appendix A

The RFW.INI File

This Appendix describes the RFW.INI file and the configuration options that it offers. It also lists the key codes that can be used in RFW.INI to define the Help and Mode keys.

The Structure of the INI File

The RFW.INI file determines the initial configuration whenever RealLink is started. It is an ASCII file and can be edited with any text editor (Windows Notepad, for example).

The file consists of a number of sections, each of which begins with a section name enclosed in square brackets. The sections present in the default file are as follows:

```
[RealLink]
[Editline]
[SaveCmds]
[SaveReps]
[ccicom.dll]
[ccidda.dll]
[executives]
[macros]
[WLANFTU]
[rfwprint.dll]
[CharacterSets]
[CharacterMappings]
```

The sections can appear in any order, and the parameters can appear in any order within each section. Section and parameter names are not case sensitive - the following are identical: rfwdir, RFWDIR, RfwDir.

[RealLink] Section

This section of the RFW.INI file can contain the following parameters:

Bitmaps=*path*

The full path of the directory containing any bitmap files used by macros or UIMS applications. For example:

Bitmaps=c:\RFW

The default setting is the directory specified by the `rfwbin` parameter.

BlinkRate=*milliseconds*

The rate in milliseconds at which flashing characters will blink. A setting of 500ms is recommended. Zero (0) means no flashing. The default setting is 500.

BrightEdge=*colour*

Specifies the colour used to draw the light edges of three-dimensional controls on the status bar. *colour* must be an RGB value, specified in decimal or, if prefixed with 0x, hexadecimal. The default value is 0xFFFFFF (white).

BusyTimerRate=*value*

This specifies the flash rate for the attention indicator on the RealLink icon, and the frequency at which RealLink will sample host activity when iconised. The default setting is 0.

ButtonBack=*colour*

Specifies the background colour used to indicate that a status bar button is selected. *colour* must be an RGB value, specified in decimal or, if prefixed with 0x, hexadecimal. The default is 0x7FFFFFFF (cyan).

ButtonText=*colour*

Specifies the foreground colour used when a status bar button is selected. *colour* must be an RGB value, specified in decimal or, if prefixed with 0x, hexadecimal. The default is 128 (dark blue).

CapsShiftToggle=[0 | 1]

Specifies whether, with the CAPS LOCK selected, the SHIFT key produces upper or lower case characters.

- 0 Shifted characters are upper case.
- 1 Shifted characters are lower case.

ConnectList=*value*

Specifies whether or not a list of RealLink sessions is displayed on the Connection menu. *value* can be set to the following:

- 0 Display a list of sessions.

If the `ConnectList` parameter is not present, no session list is displayed.

DarkEdge=colour

Specifies the colour used to draw the dark edges of three-dimensional controls on the status bar. *colour* must be an RGB value, specified in decimal or, if prefixed with 0x, hexadecimal. The recommended values are

VGA 0x808080 (dark grey)
EGA 0 (black)

The default setting is 0x808080 (dark grey).

DefColSelMode=value

This specifies the default text selection mode: 0 for line mode, or 1 for column mode. In either case, pressing the ALT key while selecting text, switches RealLink into the other mode. The default setting is 0.

Help=HelpProgram {parameters}

This specifies a program that will be called when the Application command on the Help menu is selected. The program name can be followed by any application-specific parameters, such as the name of a help file. For example:

```
Help=C:\RFW\RFWHELP C:\RFW\HLP\QRGC1.HLP
```

This specifies the program C:\RFW\RFWHELP as the help application and C:\RFW\HLP\QRGC1.HLP as the help file.

The application command line can also include the following parameters:

\$C or \$c When the help application is called, these characters are replaced with the name of the configuration (CFG) file that is currently loaded.

\$(S | s) (Column, Row, Count)
When the help application is called, these characters are replaced with text currently displayed in the RealLink window, as specified by the *Column*, *Row* and *Count* parameters.

Refer to Appendix E for more details of these parameters.

If no program is specified, the Help Application command is disabled.

helpkey=keycode

This specifies which key is used as the Help key; that is, the key that displays context-sensitive help; Chapter 5 describes the use of this key.

The available key code values are listed on pages A-110 to A-111. The default is 4159 (CTRL+?).

helppath=path

The full path of the directory containing the RealLink help files. For example:

```
helppath=C:\RFW\HLP
```

If this entry is not present, no help will be available.

Identity=string

This specifies the response string returned in response to a VT220 inquiry command from the host. The default is "MDC-P9".

LeaveAlone=value

By default, if the user presses ALT+RETURN, RFW.INI will be displayed for editing in the Windows Notepad text editor. Setting the LeaveAlone entry to 1 disables this.

LoadDlls=list

Specifies DLLs to be loaded when RealLink is started. *list* is a list of DLL names, separated by semicolons. The DLLs are assumed to be in the directory specified by the *rfgbin* parameter unless otherwise specified. The suffix '.dll' will be added if none is supplied. A DLL name may be immediately followed by a parameter string within parentheses.

For example:

`LoadDlls=gen-ex1(S)`

loads the DLL, *gen-ex1*, with the parameter "S". This displays the current cursor position in the right most section of the status bar.

MacroDir=path

The full path of the directory containing your macro script files. For example:

`MacroDir=C:\RFW`

If this entry is not present, the directory specified by the *rfgdir* parameter is used.

MaximumPasteRateInCPS=value

This specifies the maximum rate (in characters per second) at which data pasted into RealLink will be transferred to the host. If you find that you lose characters when you transfer large amounts of data to the host, try setting this entry to 300.

modekey=keycode

This specifies the key used to switch between normal and text selection mode. The available key code values are listed on pages A-110 to A-111. The default is 266 (SCROLL LOCK).

multinatxlt={path}filename

The path (optional) and name of the '.xlt' file that RealLink uses for character translation of characters transmitted to remote hosts in multi-national keyboard mode. The default is:

`multinatxlt=rfgtx`

natxlt={path}filename

The path (optional) and name of the '.xlt' file that RealLink uses for character translation of characters transmitted to remote hosts in national keyboard mode. If this entry is not present, or is set to null, RealLink will automatically use the correct translation table for the selected nationality. The default setting is null.

resourcepath=path

The full path of the directory containing the RealLink resource files. For example:

```
resourcepath=C:\RFW\RES
```

rfwbin=path

The full path of the RealLink program directory. For example:

```
rfwbin=c:\RFW
```

For local installations, this will be a directory on your PC; for network installations, it will be a directory on the server system.

rfwdir=path

The full path of your RealLink user directory (containing the RealLink message file and your configuration files). For example:

```
rfwdir=C:\RFW
```

For local RealLink installations, this directory will be the same as 'rfwbin' (see above); for network installations it will be a directory on your PC.

StatusBar=[0 | 1]

This parameter is set by the Setup Status Bar command, and determines whether or not the RealLink Status Bar will be displayed. It can be set to the following values:

- 0 Do not display the Status Bar.
- 1 Display the Status Bar.

The default setting is 0.

StatusColour=*colour*

Specifies the background colour used on the status bar. *colour* must be an RGB value, specified in decimal or, if prefixed with 0x, hexadecimal. The recommended values are

```
VGA 0xc0c0c0 (light grey)
EGA 0xffffffff (white)
```

The default setting is 0xc0c0c0 (light grey).

StatusFont=*fontname-pointsize*

Specifies the font and point size of text used on the status bar. The font name and the point size must be separated by a single hyphen, with no spaces. Default value is MS Sans Serif-10

StripSpaces=[0 | 1]

This parameter is set by the Edit Strip Spaces command, and determines whether or not Reallink removes trailing spaces on text selection operations. It can be set to the following values:

- 0 Do not remove trailing spaces.
- 1 Remove trailing spaces.

The default setting is 0.

TableFormat=*string*

This parameter is set when you click the Save as Default button in the Edit Configure Table dialog box. It specifies the default settings used by the Edit Copy Table command.

string consists of the following fields, separated by tilde (~) characters:

1. Parsing separator.
2. Paste column separator.
3. Paste row separator.
4. Not formatted on display (1 for selected, 0 for not selected).

Note: Control and non-printable characters are represented by a backslash followed by two upper case hexadecimal digits representing the ASCII code for the character. For example:

```
Tab \09
Carriage return \0D
Line feed\0A
Backslash\5C
```

The default is "~ ~\09~\0D~0".

[Editline] Section

This section of the RFW.INI file contains settings for the Line Edit command on the Edit menu. It can contain the following parameters:

CmdStack=*value*

Determines the behaviour of the Line Edit command. *stack* can be set to the following:

- 0 Line Edit is enabled, but does not stack commands.

- 1 Line Edit is enabled, and commands used are added to the list of commands in the Line Edit dialog.

Note: If the CmdStack parameter is not present, the Line Edit command is disabled and cannot be used.

MaxHist=*commands*

Specifies the maximum number of commands that can be displayed in the Line Edit dialog. The default is 20.

MaxRep=*strings*

Defines the maximum number of replacement strings that can be displayed in the Line Edit dialog. The default is 20.

Password=*string*

Specifies a string of characters that will be recognised as the host's password prompt. When the host displays this string, any text entered by the user in response, up to the next carriage return, will not be added to the list of commands in the Line Edit dialog. The default is "PASSWORD". Note that *string* is not case sensitive.

RepStr=*string*

Specifies a string of up to three characters that is used to separate search strings from replacement strings in the Replace list box. The default is:

```
RepStr=->
```

[SaveCmds] Section

The entries in this section of the RFW.INI file define commands to be pre-loaded into the list of previously used commands in the Line Edit dialog box. Each entry must be in the format:

Cn=string

where:

- n* specifies the position in the list at which the command will appear. Position numbers must start at 1 and be contiguous. If a number is omitted, commands after the omitted number will not be loaded. The maximum number of commands that can be loaded is MaxHist - 1 (see the [Editline] section above).

string is the command to be loaded, including any parameters and options.

For example:

```
C1=TERM , , , , , , , 4
C2=LOGTO MX-1
```

[SaveReps] Section

The entries in this section of the RFW.INI file define commands to be pre-loaded into the list of previously used Replace commands in the Line Edit dialog box. Each entry must be in the format:

search_string=replacement_string

For example:

```
ME=BASIC
BASIC=CATALOG
```

The maximum number of commands that can be loaded is MaxRep - 1 (see the [Editline] section on the previous page).

DLL Sections

These sections of the RFW.INI file contain the settings for the communications DLLs. There are currently two of these: CCICOM.DLL and CCIDDA.DLL. In each of these sections, settings for the following parameters can be specified:

title=string

This specifies the title displayed in the Protocol list in the Communications dialog box, and elsewhere in ReaLink. The default setting is the name of the DLL file.

[executives] Section

The entries in this section specify the DLLs required by various RPOs and terminal executives. These are set when you install ReaLink or the RPO concerned and must not be changed.

[macros] Section

This section of the RFW.INI file specifies settings for the Macro menu and the Macro Select command. It can contain the following entries:

MacroEdit=program

This specifies the editor to be used when creating and modifying macros. The specified program will be started when the user clicks the Edit button in the Macro Select dialog box.

If this entry is not present, the Edit and Delete buttons do not appear in the Macro Select dialog box.

The remaining entries specify the macro commands to be displayed on the Macro menu, and are set by the Macro Select command. Each entry is in the format:

Mn=string

where:

n specifies the position in the list at which the command will appear. Position numbers must start at 1 and be contiguous. If a number is omitted, macros after the omitted number will not be loaded. A maximum of nine macros can be displayed on the Macro menu.

string is the name of the macro file.

For example:

```
M1=Applic1
M2=Applic2
```

[WLANFTU] Section

The entries in this section are set by the LanFTU application. Most of these are set when you use LanFTU and must not be changed. You can, however, set the following entry:

`BLOCKSIZE=kilobytes`

Specifies the size in kilobytes of the data transfer buffer on the PC. It can be set to any value from 1 to 32. The default is 32.

[rfwprint.dll] Section

The following parameters are set by the Printer Font dialog and specify the font used when printing. If no font is specified, the selected printer's default font is used.

`FaceName=fontname`

`PointSize=value`

`Bold=[0 | 1]`

`Italic=[0 | 1]`

The remaining two entries control whether or not a form feed character (new page command) is sent to the printer when printing completes. In both cases, *value* can be set to the following:

- 0 Do not send a terminating form feed. Try this setting if a blank page is ejected at the end of your printout.
- 1 Send a terminating form feed. Try this setting if nothing is printed or the last page of your printout is not ejected.

`PrintAppendFF=[0 | 1]`

This is the form feed setting for Spooled and Direct printing.

`WindowPrintAppendFF=[0 | 1]`

This is the form feed setting for Print Window and Print Selection.

[CharacterSets] Section

The entries in this section must not be changed by the user.

[CharacterMappings] Section

The entries in this section must not be changed by the user.

Key Codes

This section lists the key codes (in hexadecimal) for all of the characters available from within RealLink for Windows. You will need these codes if you redefine the Mode and/or Help keys.

Table A-1. Key Codes

| Key | Description | Code | Key | Description | Code |
|-----|-------------------|------|-----|---------------|------|
| ← | backspace | 0x08 | . | period | 0x2E |
| → | tab | 0x09 | / | slash | 0x2F |
| | clear | 0x0C | 0 | zero | 0x30 |
| ↵ | return | 0x0D | 1 | one | 0x31 |
| ESC | escape | 0x1B | 2 | two | 0x32 |
| | space | 0x20 | 3 | three | 0x33 |
| ! | exclamation mark | 0x21 | 4 | four | 0x34 |
| " | double quote | 0x22 | 5 | five | 0x35 |
| # | number sign | 0x23 | 6 | six | 0x36 |
| \$ | dollar | 0x24 | 7 | seven | 0x37 |
| % | percent | 0x25 | 8 | eight | 0x38 |
| & | ampersand | 0x26 | 9 | nine | 0x39 |
| ' | apostrophe | 0x27 | : | colon | 0x3A |
| (| left parenthesis | 0x28 | ; | semicolon | 0x3B |
|) | right parenthesis | 0x29 | < | less than | 0x3C |
| * | asterisk | 0x2A | = | equals | 0x3D |
| + | plus | 0x2B | > | greater than | 0x3E |
| , | comma | 0x2C | ? | question mark | 0x3F |
| - | minus | 0x2D | @ | at symbol | 0x40 |
| A | | 0x41 | X | | 0x58 |
| B | | 0x42 | Y | | 0x59 |
| C | | 0x43 | Z | | 0x5A |
| D | | 0x44 | [| left bracket | 0x5B |
| E | | 0x45 | \ | backslash | 0x5C |
| F | | 0x46 |] | right bracket | 0x5D |
| G | | 0x47 | ^ | circumflex | 0x5E |
| H | | 0x48 | _ | underscore | 0x5F |
| I | | 0x49 | ` | left quote | 0x60 |
| J | | 0x4A | ' | right quote | 0x61 |
| K | | 0x4B | { | left brace | 0x7B |
| L | | 0x4C | | bar | 0x7C |

(continued)

Table A-1 Key Codes (continued)

| Key | Description | Code | Key | Description | Code |
|-------------|----------------|-------|--------|-----------------|-------|
| M | | 0x4D | } | right brace | 0x7D |
| N | | 0x4E | ~ | tilde | 0x7E |
| O | | 0x4F | DELETE | delete | 0x7F |
| P | | 0x50 | ↑ | up | 0x100 |
| Q | | 0x51 | ↓ | down | 0x101 |
| R | | 0x52 | ← | left | 0x102 |
| S | | 0x53 | → | right | 0x103 |
| T | | 0x54 | PG UP | page up | 0x104 |
| U | | 0x55 | PG DN | page down | 0x105 |
| V | | 0x56 | INSERT | insert | 0x106 |
| W | | 0x57 | HOME | Home | 0x107 |
| END | end | 0x108 | F7 | function key 7 | 0x206 |
| | help | 0x109 | F8 | function key 8 | 0x207 |
| SCROLL LOCK | scroll lock | 0x10A | F9 | function key 9 | 0x208 |
| | cancel | 0x110 | F10 | function key 10 | 0x209 |
| F1 | function key 1 | 0x200 | F11 | function key 11 | 0x20A |
| F2 | function key 2 | 0x201 | F12 | function key 12 | 0x20B |
| F3 | function key 3 | 0x202 | F13 | function key 13 | 0x20C |
| F4 | function key 4 | 0x203 | F14 | function key 14 | 0x20D |
| F5 | function key 5 | 0x204 | F15 | function key 15 | 0x20E |
| F6 | function key 6 | 0x205 | | | |

There are also a number of keys which can be used on their own or held down to modify other keys. If one of these keys is used as a modifier, its modifier value should be added to the key code of the key with which it is combined. These keys are listed in Table A-2.

Table A-2. Key Modifiers

| Key | Description | Code | Modifier |
|-----------|-------------|------|----------|
| CAPS LOCK | | 0x01 | 0x8000 |
| NUM LOCK | | 0x02 | 0x4000 |
| SHIFT | | 0x03 | 0x2000 |
| CTRL | Control key | 0x04 | 0x1000 |
| ALT | Alt key | 0x05 | 0x0800 |

Appendix B

ANSI Escape Sequences

This appendix lists the escape sequences that are recognised by a Prism terminal in ANSI Mode and indicates whether or not they are fully supported by RealLink. It gives details of those sequences which are not fully supported. For full details of these escape sequences, refer to the *Models 12120, 12140, 12121 and 12141 Programmer's Reference Manual*.

It also lists those escape sequences which are required for support of DEC VT220 emulation, and sequences that are unique to RealLink.

Supported Escape Sequences

Table B-1. ANSI Escape Sequences

| Mnemonic | Syntax | Function | |
|---------------------|---------------------------------|----------------------------------|-----------|
| Control Functions | | | |
| ESC | ESC (hex 1B) | Escape | Supported |
| CSI | CSI (hex 9B or ESC [) | Control Sequence Introducer | Supported |
| DCS | DCS (hex 90) | Device Control String | Supported |
| ST | ST (hex 9C or ESC \) | String Terminator | Supported |
| CAN | CAN (hex 18) | Cancel | Supported |
| SUB | SUB (hex 1A) | Substitute | Supported |
| SM | CSI <i>Pm</i> ; ... <i>Pm</i> h | Set Mode | Supported |
| RM | CSI <i>Pm</i> ; ... <i>Pm</i> l | Reset Mode | Supported |
| Formatting Data | | | |
| CR | CR (hex 0D) | Carriage Return | Supported |
| LF | LF (hex 0A) | Line Feed | Supported |
| IND | IND (hex 84) | Index (=LF) | Supported |
| VT | VT (hex 0B) | Vertical Tab (=LF) | Supported |
| NEL | NEL (hex 85) | Next Line (=CRLF) | Supported |
| RI | RI (hex 8D) | Reverse Index | Supported |
| FF | FF (hex 0C) | Form Feed | Supported |
| BS | BS (hex 08) | Backspace | Supported |
| REP | CSI <i>Pn</i> b | Repeat | Supported |
| Cursor Manipulation | | | |
| CUU | CSI <i>Pn</i> A | Cursor Up | Supported |
| CUD | CSI <i>Pn</i> B | Cursor Down | Supported |
| CUF | CSI <i>Pn</i> C | Cursor Forward | Supported |
| CUB | CSI <i>Pn</i> D | Cursor Back | Supported |
| CNL | CSI <i>Pn</i> E | Cursor Next Line | Supported |
| CPL | CSI <i>Pn</i> F | Cursor Preceding Line | Supported |
| CUP | CSI <i>Pl</i> ; <i>Pc</i> H | Cursor Position | Supported |
| HVP | CSI <i>Pi</i> ; <i>Pc</i> f | Horizontal and Vertical Position | Supported |
| CHA | CSI <i>Pc</i> G | Cursor Horizontal Absolute | Supported |
| HPA | CSI <i>Pc</i> ` | Horizontal Position Absolute | Supported |
| HPR | CSI <i>Pn</i> a | Horizontal Position Relative | Supported |
| HPB | CSI <i>Pn</i> j | Horizontal Position Backward | Supported |
| VPA | CSI <i>Pi</i> d | Vertical Position Absolute | Supported |

(continued)

Table B-1. ANSI Escape Sequences (continued)

| Mnemonic | Syntax | Function | |
|-----------------------------|-----------------------------|-----------------------------------|----------------|
| Cursor Manipulation (cont.) | | | |
| VPR | CSI <i>Pn e</i> | Vertical Position Relative | Supported |
| VPB | CSI <i>Pn k</i> | Vertical Position Backward | Supported |
| MDRVAM | CSI < 6 I (or h) | Relative Vertical Addressing Mode | Supported |
| MDVCM | CSI < 4 I (or h) | Visible Cursor Mode | Supported |
| Cursor Tabulation | | | |
| HTS | HTS (hex 88) | Horizontal Tab Set | Supported |
| HTSA | CSI <i>Pc ; ... Pc sp N</i> | Horizontal Tab Set Absolute | Supported |
| TBC | CSI <i>Pc g</i> | Tab Clear | Supported |
| CTC | CSI <i>Po w</i> | Cursor Tabulation Control | Supported |
| HT | HT (hex 09) | Horizontal Tab | Supported |
| CHT | CSI <i>Pn l</i> | Cursor Horizontal Tab | Supported |
| CBT | CSI <i>Pn Z</i> | Cursor Backward Tab | Supported |
| Character-Set Selection | | | |
| MDMNM | CSI < 16 I (or h) | Multinational Mode | Supported |
| SCS0 | ESC (<i>Dscs</i> | Select Character Set in G0 | Supported |
| SCS1 | ESC) <i>Dscs</i> | Select Character Set in G1 | Supported |
| SCS2 | ESC * <i>Dscs</i> | Select Character Set in G2 | Supported |
| SCS3 | ESC + <i>Dscs</i> | Select Character Set in G3 | Supported |
| LS0 | SI (hex 0F) | Lock Shift G0 | Supported |
| LS1 | SO (hex 0E) | Lock Shift G1 | Supported |
| LS2 | ESC n | Lock Shift G2 | Supported |
| LS3 | ESC o | Lock Shift G3 | Supported |
| LS1R | ESC ~ | Lock Shift G1, Right | Supported |
| LS2R | ESC } | Lock Shift G2, Right | Supported |
| LS3R | ESC | Lock Shift G3, Right | Supported |
| MDSS1 | PU2 (hex 92) | Single Shift G1 | Supported |
| SS2 | SS2 (hex 8E) | Single Shift G2 | Supported |
| SS3 | SS3 (hex 8F) | Single Shift G3 | Supported |
| Video Attributes | | | |
| MDSCA | CSI <i>Pa % {</i> | Select Character Attribute | Supported |
| SGR | CSI <i>Pa ; ... Pa m</i> | Select Graphic Rendition | See page B-124 |
| MDSLAL | CSI <i>Pa % </i> | Select Line Attributes | Supported |

(continued)

Table B-1. ANSI Escape Sequences (continued)

| Mnemonic | Syntax | Function | |
|-------------------|--|------------------------------|-----------------------|
| Editing | | | |
| ICH | CSI <i>Pn</i> @ | Insert Character | Supported |
| DCH | CSI <i>Pn</i> P | Delete Character | Supported |
| IL | CSI <i>Pn</i> L | Insert Line | Supported |
| DL | CSI <i>Pn</i> M | Delete Line | Supported |
| IRM | CSI 4 I (or h) | Insertion Replacement Mode | Supported |
| ECH | CSI <i>Pn</i> X | Erase Character | Supported |
| EF | CSI <i>Pe</i> N | Erase in Field | Supported |
| EL | CSI <i>Pe</i> K | Erase in Line | Supported |
| ED | CSI <i>Pe</i> J | Erase in Display | Supported |
| EM | CSI 6 I (or h) | Erasure Mode | Supported |
| MDDEM | CSI < 5 I (or h) | Data Erasure Mode | Supported |
| Page Manipulation | | | |
| MDDPL | CSI <i>Pp</i> ; <i>Pl</i> ; <i>Pc</i> ; <i>Pe</i> % w | Define Page Layout | <i>See page B-122</i> |
| MDSDF | CSI <i>Pp</i> ; <i>Pc</i> ; <i>Pf</i> % x | Set Display Format | <i>See page B-125</i> |
| MDSSA | CSI <i>Ps</i> ; <i>Pe</i> % v | Set Scrolling Area | Supported |
| MDWSM | CSI < 14 I (or h) | Wide Screen Mode | Supported |
| PPA | CSI <i>Pp</i> sp P | Page Position Absolute | <i>Ignored</i> |
| PPR | CSI <i>Pn</i> sp Q | Page Position Relative | <i>Ignored</i> |
| PPB | CSI <i>Pn</i> sp R | Page Position Backward | <i>Ignored</i> |
| MDSPSM | CSI < 11 I (or h) | Save Page State Mode | <i>Ignored</i> |
| MDSPS | CSI % y | Save Page State | <i>Ignored</i> |
| MDRPS | CSI % z | Restore Page State | <i>Ignored</i> |
| MDPDA | CSI <i>Pp</i> % p | Page Display Absolute | <i>Ignored</i> |
| NP | CSI <i>Pn</i> U | Next Page | <i>Ignored</i> |
| PP | CSI <i>Pn</i> V | Preceding Page | <i>Ignored</i> |
| MDNS | CSI % q | Next Screen | <i>Ignored</i> |
| MDPS | CSI % r | Preceding Screen | <i>Ignored</i> |
| MDSDL | CSI % s | Screen Data Left (Screen →) | <i>Ignored</i> |
| MSDSR | CSI % t | Screen Data Right (Screen ←) | <i>Ignored</i> |
| SU | CSI <i>Pn</i> S | Scroll Up (Scroll Forward) | <i>Ignored</i> |
| SD | CSI <i>Pn</i> T | Scroll Down (Scroll Back) | <i>Ignored</i> |
| SL | CSI <i>Pn</i> sp @ | Scroll Left (Scroll →) | <i>Ignored</i> |
| SR | CSI <i>Pn</i> sp A | Scroll Right (Scroll ←) | <i>Ignored</i> |

(continued)

Table B-1 ANSI Escape Sequences (continued)

| Mnemonic | Syntax | Function | |
|---------------------------|---|--|----------------|
| Page Manipulation (cont.) | | | |
| MDAPDM | CSI < 7 I (or h) | Active Page Display Mode | <i>Ignored</i> |
| MDSKAM | CSI < 13 I (or h) | Screen/Scroll Keys Action Mode | Supported |
| System Messages | | | |
| MDSMS | CSI <i>Pc</i> % } | System Message Start | Supported |
| MDSMDM | CSI < 8 I (or h) | System Message Display Mode | Supported |
| Keyboard | | | |
| MDSAK | CSI <i>Pk</i> ~ | Special Action Key | Supported |
| MDSAKS | CSI <i>Pk</i> } | Special Action Key with Shift | Supported |
| MDSAKC | CSI <i>Pk</i> { | Special Action Key with Control | Supported |
| KAM | CSI 2 I (or h) | Keyboard Action Mode | Supported |
| MDDFK | DCS <i>Pk</i> % p <i>Sk</i> ST | Define Function Key <i>Note:</i> In VT220 mode, function keys F1 to F4 cannot be redefined. | Supported |
| MDEKM | CSI < 17 I (or h) | Extended Keypad Mode | Supported |
| Communications | | | |
| XON | XON (hex 11) | Transmission On | Supported |
| XOFF | XOFF (hex 13) | Transmission Off | Supported |
| S7C1T | ESC sp F | Select 7-bit C1 code Transmission | Supported |
| S8C1T | ESC sp G | Select 8-bit C1 code Transmission | Supported |
| Printing | | | |
| MDPOC | CSI < <i>Po</i> ; <i>Ps</i> ; <i>Pe</i> i | Printer Output Control | Supported |
| MC | CSI <i>Po</i> i | Media Copy | Supported |
| Terminal Control | | | |
| MDSTR | CSI & P | Soft Terminal Reset | Supported |
| RIS | ESC c | Reset to Initial State (Hard Terminal Reset) | Supported |
| MDEM | CSI < 12 I (or h) | MDC Mode | Supported |
| BEL | BEL (hex 07) | Bell | Supported |
| Configuration Reporting | | | |
| MDRDC | CSI < <i>Ps</i> c | Report on Device Configuration | Supported |
| DA | CSI <i>Ps</i> c | Device Attributes | Supported |
| MDTCR | CSI < 10 ; <i>Pm</i> ; <i>Pb</i> ; <i>Pn</i> ; <i>Pv</i> c | Terminal Configuration Report | Supported |

(continued)

Table B-1 ANSI Escape Sequences (continued)

| Mnemonic | Syntax | Function | |
|---------------------------------|---|-------------------------------|----------------|
| Configuration Reporting (cont.) | | | |
| MDSCR | CSI < 11 ; <i>Pp</i> ; <i>Pl</i> ; <i>Pc</i> ; <i>Pfc</i> | Screen Configuration Report | Supported |
| MDPCR | CSI < 12 ; <i>Pt c</i> | Printer Configuration Report | Supported |
| MDKCR | CSI < 13 ; <i>Pl</i> ; <i>Pn c</i> | Keyboard Configuration Report | Supported |
| Status Reporting | | | |
| DSR | CSI <i>Pt n</i> | Device Status Report | Supported |
| MDRDS | CSI < <i>Ps n</i> | Report on Device Status | Supported |
| CPR | CSI <i>Pl</i> ; <i>Pc R</i> | Cursor Position Report | Supported |
| MDKSR | CSI < 13 ; <i>Pm</i> ; <i>Pg n</i> | Keyboard Status Report | Supported |
| MDPSR | CSI < 12 ; <i>Pg</i> ; <i>Pb n</i> | Printer Status Report | Supported |
| MDSSR | CSI < 11 ; <i>Pp</i> ; <i>Pl</i> ; <i>Pc</i> ; <i>Pq n</i> | Screen Status Report | Supported |
| MDTSR | CSI < 10 ; <i>Pe</i> ; <i>Pg n</i> | Terminal Status Report | Supported |
| Downloaded Character Sets | | | |
| MDLCS | DCS <i>Pb</i> ; <i>Pc</i> ; <i>Pe % q</i> <i>Dscs S1</i> ; <i>S2</i> ; ... <i>Sn</i> ST | Load Character Shapes | <i>Ignored</i> |
| MDLCM | DCS <i>Pb</i> ; <i>Pc</i> ; <i>Pe % r</i> <i>Dscs S1</i> ; <i>S2</i> ; ... <i>Sn</i> ST | Load Character Map | <i>Ignored</i> |

Note: Terminal Executives cannot be downloaded.

Table B-2. Additional Functions for DEC VT220 Support

| Mnemonic | Function | Notes | |
|---------------------|----------------------------|------------------------|----------------|
| Cursor Manipulation | | | |
| DECTCEM | Text Cursor Enable Mode | As MDVCM | Supported |
| DECOM | Origin Mode | As MDRVAM | Supported |
| Editing | | | |
| DECSEL | Selective Erase in Line | Sets MDDEM and uses EL | Supported |
| DECSER | Selective Erase in Display | Sets MDDEM and uses ED | Supported |
| Video Attributes | | | |
| DECSCA | Select Character Attribute | Subset of MDSCA | Supported |
| DECDHL | Double Height Line | | <i>Ignored</i> |
| DECDWL | Double Width Line | | <i>Ignored</i> |
| DECSWL | Single Width Line | | <i>Ignored</i> |

(continued)

Table B-2 Additional Functions for DEC VT220 Support (continued)

| Mnemonic | Function | Notes | |
|-------------------|-----------------------------------|----------------------|-----------|
| Page Manipulation | | | |
| DECSTBM | Set Top and Bottom Margins | Identical to MDSSA | Supported |
| DECSC | Save Cursor | Identical to MDSPS | Supported |
| DECRC | Restore Cursor | Identical to MDRPS | Supported |
| DECCOLM | Column Mode | Identical to MDWSM | Supported |
| Keyboard | | | |
| DECKPAM | Keypad Application Mode | Sets MDEKM | Supported |
| DECKPNM | Keypad Numeric Mode | Resets MDEKM | Supported |
| DECCKM | Cursor Key Mode | | Supported |
| Communications | | | |
| DECSCCL | Set Compatibility Level | Level 2 options only | Supported |
| Printing | | | |
| | Printer Control Sequence | Subset of MDPOC | Supported |
| Terminal Control | | | |
| DECSTR | Soft Terminal Reset | Identical to MDSTR | Supported |
| DECANM | ANSI Mode | Similar to MDP8EM | Supported |
| Reporting | | | |
| | Primary Device Attributes (DEC) | Setup option | Supported |
| | Secondary Device Attributes (DEC) | | Supported |
| | Device Status Reporting (DEC) | Printer only | Supported |

Page Manipulation Commands

The following escape sequences are supported on RealLink for Windows, but with reduced functionality.

MDDPL

Define Page Layout - specifies the structure of a page.

Syntax

`CSI Pp ; Pl ; Pc ; Ps ; Pe ; Pf % w`

Syntax Elements

Pp Page number. Ignored - page 1 is always selected.

Pl Number of lines. Default value = 24.

Pc Number of columns. Default value = 80 or 132 (see MDSDF).

Ps Start of scrolled area. Ignored.

Pe End of scrolled area. Ignored.

Pf Format options. Ignored.

Remarks

This escape sequence defines the layout of a page. The layout parameters remain in force until another escape sequence for the page is received or a reset occurs.

This escape sequence has no immediate effect and must be followed by an MDSDF sequence to action the definition. No data or escape sequences may be sent to the terminal between the MDDPL and MDSDF sequences.

MDSDF

Set Display Format - defines the display buffer and video formats.

Syntax

`CSI Pp ; Pc ; Pf % x`

Syntax Elements

Pp Number of pages. Ignored.

Pc Number of display columns. Value: 80 or 132. Default = 80.

Pf Format options. Ignored. Single Active Page (SAP) format is always selected.

Remarks

Reinitialises the video display and the buffers to the new format specified in this escape sequence, and in any preceding MDDPL sequence defining the page one layout (see above).

All pages are cleared by this escape sequence. They are also reinitialised to place the cursor in the top left-hand corner, and to set the current per-character video attributes to normal. Page one is made the current 'active' page and the current 'display' page.

Video Attributes

The following escape sequence is fully supported on RealLink for Windows, but also provides additional functionality.

SGR

Select Graphic Rendition - defines the video attributes for subsequent characters.

Syntax

`CSI Pa ; ... Pa m`

Syntax Elements

Pa Attribute (selective). Default value = 0.

| <i>Pa</i> | Effect | <i>Pa</i> | Effect | <i>Pa</i> | Effect |
|-----------|--------------------------------|-----------|-----------------------|-----------|--------------------|
| 0 | Clear all attributes | 30 | Black foreground | 40 | Black background |
| 1 | Bold | 31 | Red foreground | 41 | Red background |
| 4 | Underline | 32 | Green foreground | 42 | Green background |
| 5 | Flashing | 33 | Yellow foreground | 43 | Yellow background |
| 7 | Reverse video | 34 | Blue foreground | 44 | Blue background |
| 22 | Normal intensity (not bold) | 35 | Magenta foreground | 45 | Magenta background |
| 24 | Not underline | 36 | Cyan foreground | 46 | Cyan background |
| 25 | Not flashing | 37 | White foreground | 47 | White background |
| 27 | Not reverse video | | | | |

Remarks

This is an alternative to MDSCA for specifying character attributes. Unlike MDSCA, a new sequence does not turn off other attributes automatically. Only if zero (or 'null') is used as the parameter, are the attributes turned off.

Note that the 'protected' attribute cannot be specified using this control sequence.

The colour attributes (*Pa* = 30 to 47) should not be used in combination with the other types of attributes. If this is done, the results will be unpredictable.

RealLink Escape Sequences

The following escape sequences are available only on RealLink for Windows 2.0 and later.

Append

Appends the currently selected text to that currently on the Windows clipboard.

Syntax

CSI 3 % n

Caps Lock Control

Controls the CAPS LOCK setting on the PC.

Syntax

CSI < 3 1 h to set the CAPS LOCK on.
CSI < 3 1 l to set the CAPS LOCK off.
Default value - as set by the user.

Clear History

Clears the terminal page and all history pages. The position of the cursor remains unchanged.

Syntax

CSI 0 % n

Copy

Copies the currently selected text to the Windows clipboard.

Syntax

CSI 1 % n

Copy Table

Copies the currently selected text to the Windows clipboard and formats it as a table as specified by the current settings of the Configure Table command.

Syntax

CSI 5 % n

Copy Window

Copies the contents of the RealLink window to the Windows clipboard.

Syntax

CSI 2 % n

Draw

Draws boxes and/or lines in the terminal window.

Syntax

CSI *BoxDefinition* {*LineDefinition* {...}} % b

BoxDefinition must consist of the following:

{*options* ;} *Hs* ; *Vs* ; *He* ; *Ve*

Hs The character position of the left-hand edge of the rectangle, relative to the left-hand edge of the terminal page.

Vs The character position of the top edge of the rectangle, relative to the top of the terminal page.

He The character position of the right-hand edge of the rectangle, relative to the left-hand edge of the terminal page. If *He* is the same as *Hs*, a vertical line is drawn.

Ve The character position of the bottom edge of the rectangle, relative to the top of the terminal page. If *Ve* is the same as *Vs*, a horizontal line is drawn.

Vs must be greater than or equal to *Hs*, and *Ve* greater than or equal to *He*.

Each *LineDefinition* must consist of the following:

; {*options* ;} *Hc*

Hc The character position of a vertical line, relative to the left-hand edge of the terminal page. The line will be the same height as the box defined in the box definition.

Options

In each case, *options* can consist of one or more of the following, separated by semicolons:

- 200 Erase (toggle). The box or line is erased, instead of drawn.
- 201 Merge (toggle). Where the box or line to be drawn or erased overlaps existing lines, the appropriate composite character is formed. Note that this option is the default for line definitions.
- 202 Horizontal (toggle). Causes horizontal lines to be drawn, instead of vertical. Line position parameters are interpreted as character row positions relative to the top of the terminal page. The lines will be the same width as the box defined in the box definition. Ignored if used in the box definition.
- 203 Keep ends (toggle). This option is similar to Erase, but where the ends of the lines intersect with the box, the lines forming the box are retained.
- 204 Do not draw (toggle). The box or line is neither drawn nor erased. This option is useful when drawing additional lines, or removing lines from an existing box.

- 205 Fill. Clears the contents of the box to spaces, using the current character attribute. If required, the colour can be changed by using the colour options listed in Table B-3 below. Note that if this option is used after drawing lines within the box, these lines will be erased.
- 206 Attribute. Sets the attributes of the inside of the box to the current settings without erasing data.
- 207 End (toggle). Draws lines with Ts on the ends.

Table B-3. Colour Options (ANSI Mode only)

| Foreground | | | | Background | | | |
|------------|---------|------|---------|------------|---------|----------------|---------|
| Normal | | Bold | | Normal | | Bold + Inverse | |
| 300 | Black | 308 | Black | 400 | Black | 408 | Black |
| 301 | Red | 309 | Red | 401 | Red | 409 | Red |
| 302 | Green | 310 | Green | 402 | Green | 410 | Green |
| 303 | Yellow | 311 | Yellow | 403 | Yellow | 411 | Yellow |
| 304 | Blue | 312 | Blue | 404 | Blue | 412 | Blue |
| 305 | Magenta | 313 | Magenta | 405 | Magenta | 413 | Magenta |
| 306 | Cyan | 314 | Cyan | 406 | Cyan | 414 | Cyan |
| 307 | White | 315 | White | 407 | White | 415 | White |

Remarks

- A Draw sequence can include up to 32 parameters. The four box-position parameters are mandatory.
- The top left-hand corner of the terminal page is position 1, 1.
- Except for the colour options listed in Table B-3, options used in the box definition do not affect line definitions.
- Sequences are evaluated from left to right. Once set, an option remains effective for all line definitions until the end of the sequence. The options marked “toggle” reverse the state of the appropriate attribute each time they occur in the sequence.

Examples

CSI 10;5;40;20%b

Draws a box 31 characters wide by 16 high, starting 10 characters from the left of the terminal window and 5 character rows from the top.

CSI 20;10;60;20;40;50%b

Draws a box 41 characters wide by 11 high, starting 20 characters from the left of the terminal window and 10 character rows from the top. The box will contain two vertical lines, one 40, and the other 50 characters from the left-hand edge of the terminal window.

CSI 30;6;50;22;202;10%b

Draws a box 21 characters wide by 17 high, starting 30 characters from the left of the terminal window and 6 character rows from the top. The box will contain a horizontal line, 10 rows from the top edge of the terminal window.

CSI 204;30;6;50;22;202;203;10%b

If used after the preceding sequence, this erases the horizontal line, leaving the box unaffected. Note that the 204 (do not draw) is part of the box definition and does not affect the line.

CSI 15;10;15;20;40;50%b

Draws three vertical lines 11 characters high, starting 10 character rows from the top of the terminal window. The lines are positioned 15, 40 and 50 characters from the left-hand edge. Note that the first line (position 15) is in fact a zero width box.

Draw Rectangle

Draws a rectangle in the terminal window.

Syntax

CSI *Hs* ; *Vs* ; *He* ; *Ve* % o

Syntax Elements

Hs The character position of the left-hand edge of the rectangle, relative to the left-hand edge of the terminal page.

Vs The character position of the top edge of the rectangle, relative to the top of the terminal page.

He The character position of the right-hand edge of the rectangle, relative to the left-hand edge of the terminal page.

Ve The character position of the bottom edge of the rectangle, relative to the top of the terminal page.

Remarks

The top left-hand corner of the terminal page is position 1, 1.

Vs must be greater than or equal to *Hs*, and *Ve* greater than or equal to *He*.

The Draw Rectangle escape sequence cannot be used to draw lines.

Fill Rectangle

Fills an area of the terminal window with a specified character and/or attribute.

Syntax

CSI *Hs* ; *Vs* ; *He* ; *Ve* { ; *Pf* { ; *Po* } } % f

Syntax Elements

Hs The character position of the left-hand edge of the area, relative to the left-hand edge of the terminal page.

- Vs* The character position of the top edge of the area, relative to the top of the terminal page.
- He* The character position of the right-hand edge of the area, relative to the left-hand edge of the terminal page.
- Ve* The character position of the bottom edge of the area, relative to the top of the terminal page.
- Pf* The ASCII code of the character with which to fill the area. If omitted, the area is filled with spaces.
- Po* One of the following ASCII characters:
- 1 Fill the area with the specified character, but do not change the character attributes within the area.
 - 2 Change the character attributes within the area to the current setting, but do not fill the area.
 - 3 Both fill the area and change the character attributes (default).

Remarks

The top left-hand corner of the terminal page is position 1, 1.

Vs must be greater than or equal to *Hs*, and *Ve* greater than or equal to *He*.

If the *Po* parameter is specified, *Pf* must also be present.

MDISTEM

Selects a terminal emulation.

Syntax

CSI *Pe* & q

Syntax Elements

- Pe* The required terminal emulation. This must be one of the following ASCII characters:
- 0 Reset the terminal emulation to that specified in the configuration (CFG) file.
 - 1 P12 terminal emulation.
 - 2 ANSI terminal emulation.
 - 3 VT220 terminal emulation.

Remarks

7- and 8-bit ANSI emulation must be selected by using this sequence in conjunction with S7C1T and S8C1T (see page B-118).

MDRDS

Requests a report on the status of a sub-device.

Syntax

CSI < *Ps* n

Syntax Elements

Ps Sub-device identifier (selective). Default value = 0.

In addition to the values supported by the Prism terminal (described in the *Models 12120, 12140, 12121 and 12141 Programmer's Reference Manual*), RealLink supports the following value for *Ps*:

4 PC status report.

Num Lock Control

Controls the NUM LOCK setting on the PC.

Syntax

CSI < 3 4 h to set the NUM LOCK on.

CSI < 3 4 l to set the NUM LOCK off.

Default value - as set by the user.

Paste

Copies text from the clipboard to the current cursor position. Each character is sent to the host system as though it was typed from your PC keyboard. The text is terminated with a NULL character (0x00).

Syntax

CSI 4 % n

PC Status Report

Reports the status of the PC. This escape sequence is generated by RealLink in response to an MDRDS escape sequence with sub-device identifier 4.

Syntax

CSI < 14 ; *Pk* ; *Pc* n

Syntax Elements

Pk Keyboard status (additive):

- 1 CAPS LOCK on.
- 2 NUM LOCK on.

Pc Clipboard status (additive):

- 1 There is text selected within the RealLink window. The Copy, Append and Copy Table sequences are available.
- 2 There is text on the clipboard.

Process Attributes

Controls whether character attributes are processed by RealLink.

Syntax

CSI < 3 2 h to enable attribute processing.
CSI < 3 2 I to disable attribute processing.
Default value - as specified in the configuration (CFG) file.

Screen Update

Controls output to the terminal page.

Syntax

CSI < 3 0 h to disable screen update.
CSI < 3 0 I to enable screen update.
Default value - enabled.

Remarks

When screen update is disabled, output to the terminal page, though not displayed, is copied into the history pages and can be displayed by re-enabling screen update.

Set Selection

Selects text within the RealLink window.

Syntax

CSI *Hs* ; *Vs* ; *He* ; *Ve* ; *Sf* % m

Syntax Elements

Hs The horizontal character position of the start of the selection, relative to the left-hand edge of the terminal page.

Vs The vertical character position of the start of the selection, relative to the top of the terminal page.

He The horizontal character position of the end of the selection, relative to the left-hand edge of the terminal page.

Ve The vertical character position of the end of the selection, relative to the top of the terminal page.

Sf The required text selection mode:
0 Line mode.
1 Column mode.

Remarks

The top left-hand corner of the terminal page is position 1, 1.

In line mode, either *Ve* must be greater than *Vs*, or *Ve* must be equal to *Vs* and *He* greater than *Hs*.

In column mode, *He* must be greater than or equal to *Hs*, and *Ve* greater than or equal to *Vs*.

Stream

Directs screen output to a file.

Syntax

DCS *Sm* % s *Sc* ST

Syntax Elements

Sm Stream mode:

- 0 Turn off streaming.
- 1 Start streaming.
- 2 Stream window (immediate).
- 3 Stream selection (immediate).

Sc A string of characters containing the following:

FileName , *Clear* , *StripFF* , *Print* , *OnFF*

where

| | |
|-----------------|---|
| <i>FileName</i> | Is the name of the file to which screen output will be sent. If no path is specified, the file will be created in your RealLink user directory. |
| <i>Clear</i> | 1 - Clear the stream file before sending any more display data. 0 - The display data is appended to any existing contents. |
| <i>StripFF</i> | 1 - Remove any form feed characters from the streamed output. 0 - Do not remove form feed characters. |
| <i>Print</i> | 1 - When streaming is turned off, print the stream file. 0 - Do not print the stream file. |
| <i>OnFF</i> | 1 - Send data to the file on receipt of each form-feed character. 0 - Send data to the file on receipt of each line-feed character. |

Appendix C

File Transfer Filters

This appendix describes how to create your own filters for use with the HOST-WS and WS-HOST commands. It also includes information on the format produced by the PASS-DOS DIF filter.

Filters

The Reality host file transfer programs (HOST-WS, WS-HOST, PASS-DOS and SPASS-DOS) generally perform some kind of reformatting of the data as it passes from Reality to DOS or vice-versa. In some cases, the reformatting involves as little as changing the end of line characters between the two systems, while in other cases, very sophisticated reformatting and reorganisation of the data is performed. The type of reformatting to be performed is specified to the data transfer program in the form of a filter.

Filter Items

Filters are held as individual items in the file RL.BP in the REALLINK account. The name of the filter is the item-id in RL.BP. Each account which has been configured to use RealLink has access to this file.

A sorted list of all filters currently held in RL.BP can be displayed by using the LIST-FILTERS command. Those that are supplied for use with HOST-WS, WS-HOST, PASS-DOS and SPASS-DOS are listed in Chapter 7.

Filter Attributes

The first four attributes of a filter have the same significance for all four file transfer commands. Attributes five onwards have formats defined by the particular command being used.

Note: Although the first four attributes of PASS-DOS and SPASS-DOS filters are described here, filters of this type are beyond the scope of this manual. The section on PASS-DOS and SPASS-DOS lists the filters that are available for these commands.

Attribute 1

Contains the string "FLT" which uniquely identifies the item as a filter.

Attribute 2

Contains a free-text description of the use of the filter.

Attribute 3

Indicates the command to which the filter belongs, as follows:

| | |
|--------|---|
| WSHWS | Specifies a filter used by WS-HOST or HOST-WS. |
| PD-xxx | Specifies a filter used by PASS-DOS and SPASS-DOS. xxx is the type of conversion that the filter is designed to handle; for example, DIF. |

If this attribute contains anything other than the above, the filter cannot be used with RealLink for Windows.

Attribute 4

The revision level of the filter. This provides a check on the compatibility of the filter for future enhancements to the programs which use it.

As a general rule, attributes four onwards can contain a comment field, separated from the filter data by a single value mark (]). All programs which use these attributes extract the first multi-value only.

Character Translation Attributes

Some filters provide for the translation of individual characters during the transfer. The translation is performed on a one to many basis and is specified by character translation attributes held in the filter.

Each translation attribute consists of two parts separated by the '>' character. The left-hand part represents the character to be translated, while the right-hand part contains a list of the required output characters. If nothing follows the '>', the character concerned is translated to a null string; i.e. it is discarded. Each character is specified as two hexadecimal digits and the output characters are separated by commas.

Example 1

The following character translation attributes convert Reality attribute marks to Carriage Return (CR) followed by Line Feed (LF), and value marks to spaces; sub-value marks are discarded:

```
FE>0D,0A
FD>20
FC>
```

Example 2

The following character translation attributes translate DOS data so that CR becomes an attribute mark, and LF and DOS end-of-file characters (0x1A) are discarded:

```
0D>FE
0A>
1A>
```

HOST-WS Filters

HOST-WS uses filter attributes 1 to 4 which conform to the filter format described in the previous section. The significance of filter attributes five onwards are:

Attribute 5

Contains one of the following conversion option letters:

- | | |
|------|--|
| null | Appends an attribute mark to the item and performs any required character translation defined by attributes seven onwards. |
| C | Specifies that the data in the host file is in compressed form and was uploaded by WS-HOST using a similar C type filter. Compressed mode is intended for temporary storage of PC files on the host when no host access is required to those files. If the C option is specified, none of the other filter attributes are used. |
| D | Specifies that the item or items are to be downloaded in their Reality format for storage in a PC file. No translation of characters is performed. The PC file is created in a special |

format which stores the items and their item-ids so that a subsequent WS-HOST is able to recreate the items exactly as they were in the original Reality file.

This feature allows data and programs to be moved between host systems via PC disks and can prove useful for low-cost distribution of programs and data files within multiple-host organisations.

If the D option is specified, none of the other filter attributes are used.

- I Specifies that each item is prefixed with a string containing "#####" followed by the item-id and an attribute mark. This allows a user-written PC program to identify the start of each item as it is processing the file.
- X Transfers the item and performs any required character translation, but, unlike the null option described above, it does not append a final attribute mark to the item.

Attribute 6

Controls whether a DOS end of text file character is written at the end of the file. The DOS end of file character is 26 (CTRL+Z) and is required by some DOS programs such as Wordstar. If this attribute contains the character Z, an end of file mark is written. If it contains null, no end of file mark is written.

Attributes 7+

Contain the hexadecimal values of the characters to be transferred and converted. Character translation attributes are described in the earlier section on filter items (page C-138).

Example

The following filter converts attribute marks into CR/LF pairs, and value and sub-value marks into spaces:

```
001 FLT
002 DEFAULT INTERNAL HOST-WS FILTER
003 WSHWS
004 1
005
006
007 FE>0D,0A
008 FD>20
009 FC>20
```

WS-HOST Filters

WS-HOST uses filter attributes 1 to 4 which conform to the format described in the section on filter items. The significance of filter attributes five onwards are:

Attribute 5

Contains the option identifier or specifies the maximum size of host items that will be created.

If attribute 5 contains a number, this defines the maximum item size; the default (used if attribute 5 is null) is approximately 30,000 bytes. If the data exceeds this maximum size, the excess data will be written to overflow items with an incrementing suffix of .0001, .0002 etc. appended to the item-id.

Note: The host can be configured so that WS-HOST can create items larger than 30,000 bytes. Refer to Chapter 3 for details.

Alternatively, filter attribute 5 can contain one of the following option letters:

C Specifies that the data is to be copied in compressed form for subsequent downloading by HOST-WS using a similar C type filter. Compressed mode is intended for temporary storage of PC files on the host when no host access is required to those files.

If the C option is specified, no other filter attributes are used.

D Specifies that the data to be copied is in Reality format as downloaded by HOST-WS using a similar D type filter. No translation of characters is performed. Note that this option allows more than one item to be created.

This feature allows data and programs to be moved between host systems via PC disks and can prove useful for low-cost distribution of programs and data files within multiple-host organisations.

If the D option is specified, none of the other filter attributes are used.

Attribute 6

Defines the action to be taken if the host item already exists. If this attribute contains the letter O (for overwrite), the existing item is automatically overwritten. If the attribute is null, you are prompted for permission to perform the overwrite.

Attributes 7+

Contain the character translation attributes as described in the section on filter items (page C-138).

Example

The following filter converts tabs into spaces, CR/LF pairs into attribute marks, and discards DOS end-of-file and 0xFF characters:

```
001 FLT
002 DEFAULT INTERNAL WS-HOST FILTER
003 WSHWS
004 1
005 30000
006
007 09>20
008 0A>
009 0D>FE
010 1A>
011 FF>
```

The DIF Format

DIF (Data Interchange Format) used by PASS-DOS and SPASS-DOS is a file format devised initially as a means of passing data between dissimilar PC programs. Files written in DIF format are acceptable as input to a large number of programs, such as Lotus 1-2-3, Samna Word, Samna Decision Graphics, Logistix, Multimate, TK-Solver, Visicalc and many others.

The DIF format is the subject of the book "The DIF File" by Donald H. Beil, published by Prentice-Hall, which reproduces the "DIF Technical Specification" originally issued by Software Arts Products Corporation, the designers of the DIF format. The book also contains examples and tutorials on the DIF format.

Although the DIF format adheres to a standard specification, you should be aware that some of the features are optional and can be ignored or treated in different ways by the various PC programs. The documentation for the programs in question should normally deal with how DIF is supported.

Note: The export of multi-values to DIF files is not directly supported by ReaLink. Conventional spreadsheets, such as Lotus 1-2-3 Rev. 2, therefore cannot handle correctly any .DIF file generated by PASS-DOS or SPASS-DOS if the original database is structured to contain multi-values.

DIF header items

When using PASS-DOS and SPASS-DOS with the DIF filter, the header section of the DIF file is constructed as follows:

- The host file name is used to create the TABLE item.
- From the dictionary items for the attributes specified, attribute three (the tag field) is used to create the LABEL item.
- The number of item-ids found in the select list determines the number of VECTORS that will be declared.
- The number of TUPLES declared in the header is the number of attributes output by the English command.

Appendix D

Connecting via a Terminal Server

This appendix describes how to configure a Northgate Multi-protocol Terminal Server so that you can transfer files to and from a UNIX host using the Zmodem file transfer commands.

If your PC is connected to a UNIX host via an asynchronous link and a Northgate Multi-protocol Terminal Server, you will need to configure the terminal server and the host correctly, so that you can use the Zmodem file transfer commands (sz and rz).

Note: The configuration given below can also improve the performance of the WS-HOST command when transferring files to a Reality database via a Northgate Multi-protocol Terminal Server.

Configuring the Terminal Server

This section lists the settings which must be made on the Terminal Server. The manual supplied with your Terminal Server describes the configuration process.

Before starting, you will need to find out whether you should use an OSI or Telnet connection. The system administrator for your UNIX host can give you this information.

Host Entry

Add a host entry with the following settings:

OSI Connection:

| | |
|-------------------|--|
| Host name: | Enter the name by which users will identify the UNIX host. |
| Connection type: | ISO |
| Ethernet address: | Enter the Ethernet address of the UNIX host. |
| Host LSAP: | FE |
| Host TSAP: | 0202 |
| Host type: | Pipe |
| Source LSAP: | FE |
| Source TSAP: | 0202 |

Telnet Connection:

| | |
|------------------------|--|
| Host name: | Enter the name by which users will identify the UNIX host. |
| Connection Type: | Telnet |
| Ethernet Address: | Enter the IP address of the UNIX host. |
| Destination Port: | 23 (confirm this with your UNIX system administrator). |
| Negotiate Binary Mode: | Yes |
| Negotiate Remote Echo: | Yes |

Set any other parameters as required for this connection.

User Entry

Add a user entry to the Name Table. This must have the following settings:

| | |
|------------------|---|
| Attention Key: | Disabled. |
| Auto-logon user: | Yes |
| Auto-logout: | Yes |
| Connection type: | Specify ISO or Telnet, depending on the type of connection defined above. |
| Host name: | Enter the host name as defined above. |

Set any other parameters as required for this user entry.

Configuring the Host

In addition to the above, you will need a character-mode, null-network listening entry in the ROUTE-FILE on your UNIX host. The *UNIX Connect, System Administration Guide* describes how to create this entry.

Appendix E

Application Help

This appendix describes how you can use ReaLink to display on-line help for your applications.

The Help Application Command

The RealLink Help menu includes a command called Application. This is provided so that RealLink can give the user help, not only for its own commands and dialogs, but also for applications running on your host system. When you first install RealLink, the Application command is disabled, but it can be enabled by setting the Help entry in the [RealLink] section of RFW.INI.

To use the Application command, you must provide a Help application for RealLink to call. For instance, if your help text is in a Windows Help file, you can use the Windows Help application, WINHELP.EXE. Edit your RFW.INI file and add the following line to the [RealLink] section:

```
Help=WINHELP HelpFile
```

where *HelpFile* is the name of the Windows Help file for your application. Any command line parameters required by your help application can be included in the Help entry.

Note: RealLink includes a Windows Help file, QRG*nn*.HLP, which provides help on Reality. The letters *nn* are replaced by the version number of the help file. Note, however, that the help file might not cover your version of Reality.

Context-sensitive Help

Using the WINHELP application as described above will provide you with help for your host applications, but you will need to search through the help file for the topic you require. On-line help is much more useful, however, if it can give the user context-sensitive help.

RealLink provides a context-sensitive capability by appending any text that is selected in the RealLink window to the command line of your Help application. For example, if you have configured the Application command to display the file C:\RFW\HLP\QRGC1.HLP and you have the text "WHO" selected in the RealLink window, when you select the Application command, the following parameters will be passed to your Help application:

```
C:\RFW\HLP\QRGC1.HLP WHO
```

WINHELP.EXE is unable to make use of this additional information, and simply displays it in the title of the Help window. However, the Help application, RFWHELP.EXE, supplied with RealLink, passes the extra parameter to WINHELP as a "Help Keyword". If the keyword can be found in the help file, the help topic associated with that keyword is displayed.

For example, if the [RealLink] section of your RFW.INI file contains the following line:

```
Help=C:\RFW\RFWHELP C:\RFW\HLP\QRGC1.HLP
```

and you have selected the word "WHO" in the RealLink window, when you select the Application command from the Help menu, a description of the Reality WHO command will be displayed.

Writing a Help Application

If neither WINHELP nor RFWHELP provides the facilities you require, you can write your own Help application. For example, you may already have help text available for

your application, but not in the Windows Help format. To display this text, you could write a special Help application.

When writing your Help application, you should be aware of the following:

When the help application is called by RealLink, it will be passed any command-line parameters specified in RFW.INI.

If any text is selected within the RealLink window, this will be appended to the command line. In RFWHELP.EXE, this text is used as a help keyword to display context-sensitive help. The appended text is separated from the command-line parameters with a space.

To help you to write your own Help applications, the source code for RFWHELP.EXE is provided in the RealLink help directory. The source file is called RFWHELP.CPP.

Note: If you use the Windows Help application (WINHELP.EXE) to display your help text (as in RFWHELP.EXE), you will find that, in Windows 3.1, attempting to display the help for a non-existent keyword simply produces an error message. The Help file concerned is not opened.

The user will find it more helpful if the help contents page is displayed, and you should therefore open the contents page of the Help file before attempting to find any keyword entry. This will ensure that, if the keyword cannot be found, the user will at least see the Help contents page.

Replaceable Parameters

The Help entry in RFW.INI can include special parameters that will help you to make your help context sensitive. These parameters are as follows:

\$C or \$c When the help application is called, these characters are replaced with the name of the configuration (CFG) file that is currently loaded.

\$(S | s) (*Column, Row, Count*)
When the help application is called, these characters are replaced with text currently displayed in the RealLink window, as specified by the *Column*, *Row* and *Count* parameters.

Column is the horizontal position of the start of the text, in character positions from the left-hand edge of the window. The left-most column is numbered 0.

Row is the vertical position of the start of the text, in character rows from the top edge of the window. The top row is numbered 0.

Count is the number of characters required.

For example, RFW.INI might contain the following Help setting:

```
Help=C:\RFW\RFWHELP $C $(0,0,10)
```

Then, if the current configuration file is ACCOUNTS.CFG and the first 10 characters of the top line of the RealLink window contain the text "Petty Cash", The RFWHELP application will be called as follows:

```
C:\RFW\RFWHELP ACCOUNTS.CFG "Petty Cash"
```

Note: Any text that is selected in the RealLink window will be appended to the help application command line.

Your help application can use this additional information in various ways. You might, for example, produce a help file for each host application - you could then use the name of the configuration file to decide which help file to display. Or you could display different help topics, depending on the text displayed at a particular location on the screen.

Appendix F

Dynamic Data Exchange

This appendix describes how other Windows applications can communicate with RealLink by means of Dynamic Data Exchange (DDE).

Introduction

RealLink provides two ways to exchange data with other applications: the Clipboard, and Dynamic Data Exchange (DDE). The Clipboard requires you to copy and paste each time you want to exchange data. DDE, however, allows one application to call on the resources of another and to control the operation of that program.

Clients and Servers

When an application initiates a DDE conversation, it is called the client; the responding application is called the server. These roles are maintained throughout the conversation and govern the types of message each application can send. Programs can be engaged in several simultaneous DDE conversations, acting as the client in one and the server in another. Windows controls these conversations, assigning each conversation a unique channel number and passing the various messages to the correct applications.

This appendix describes how to use RealLink as a server. It assumes that you will be writing macros in another application, such as Word for Windows or Excel, and describes the different DDE commands that RealLink understands.

Topics and Items

Each DDE conversation is established on a particular topic, usually a data file of some kind, with the conversation thereafter limited to the data items associated with that topic. In the case of RealLink, this data file is the configuration file used to establish a connection to a host system. The items in a conversation with RealLink are host commands and the data returned by the host for display in the RealLink window.

DDE Messages

The following table lists the DDE messages to which RealLink will respond.

Table F-1. DDE Messages

| Message | Description | RealLink Options |
|-----------|--|---|
| INITIATE | Sent by another application to RealLink, indicating that the client wants to start a DDE conversation. | "RFWDDE" must be specified as the application and the name of a configuration (CFG) file as the topic. |
| REQUEST | Sent by a client application requesting the transfer of a data item. | Valid items are the current cursor position, and all or part of one or more rows of text displayed on the screen. |
| POKE | Unsolicited data sent by a client application. | The data is sent to the host as if it had been typed at the keyboard. |
| EXECUTE | A string sent by a client application, representing commands to be carried out by RealLink. | Valid commands allow data transmitted by the host to be collected in a buffer, and the restoration of normal operation. |
| TERMINATE | Sent by a client application to end a DDE conversation. | A second DDE conversation cannot be started until the first has been terminated. |

Configuring RealLink for DDE

If you intend using RealLink's DDE server functions, you must load the DLL, RFWDDDE.DLL. This can be done from the command line by using the /L switch as described in Chapter 3, or by setting the LoadDlls parameter in the [RealLink] section of the RFW.INI file as described in Appendix A.

For example, the following command line starts RealLink and loads the RFWDDDE DLL:

```
C:\RFW\RFW.EXE /LC:\RFW\RFWDDDE.DLL
```

The following entry in the [RealLink] section of RFW.INI ensures that the RFWDDDE DLL is loaded whenever RealLink is started:

```
LoadDlls=RFWDDDE
```

Using DDE

This section lists the RealLink DDE Server commands. To call these, you will need to use the appropriate DDE commands in your client application or programming language. The examples all use the Word for Windows 2.0 WordBASIC macro language.

Initiating a DDE Conversation

Before you can use any of the other DDE commands, you must initiate a DDE conversation with RealLink. For example, in Word for Windows, you would call the DDEInitiate() function, while in Excel, you would use INITIATE.

To initiate a DDE conversation, you must specify the name of the server application and the name of a DDE topic. In RealLink, the application name must be "RFWDDE", and the topic must be the name of a configuration (CFG) file. Note that RealLink must already be running, with the specified configuration file loaded.

Example

```
App$ = "RFWDDE" ' The name of the RealLink DDE Server
Topic$ = "ACCOUNTS" ' The ACCOUNTS.CFG configuration file
ChanNum = DDEInitiate(App$, Topic$)
```

Terminating a DDE Conversation

When your DDE conversation is over, you must terminate it. If you do not do this, you will not be able to reconnect for a subsequent conversation. In Word for Windows, you would call either DDETerminate or DDETerminateAll, while in Excel, you would use TERMINATE. Note that you must specify the channel number returned when you initiated the conversation.

Example

```
DDETerminate ChanNum ' ChanNum is returned by DDEInitiate()
```

Sending Data to RealLink

You can send data to RealLink by using a command that generates a DDE POKE message. For example, in Word for Windows you would use the DDEPoke statement, and in Excel, the POKE function. You will need to specify three parameters:

- The channel number returned when you initiated the DDE conversation.
- A conversation item. In RealLink, this must be a null string.
- The data to be sent.

The data received by RealLink is transmitted to host as if it had been typed at the keyboard.

Example

```
Item$ = "" ' Item must be a null string
Data$ = "WHO" + Chr$(13) ' The host command to carry out
DDEPoke ChanNum, Item$, Data$ ' ChanNum returned by DDEInitiate()
```

Obtaining Data from RealLink

You can request data from RealLink by using a command that generates a DDE REQUEST message. For example, in Word for Windows you would use the DDERequest\$() function, and in Excel, the REQUEST function. A command consists of

an Item string containing the command name together with any parameters. You must also specify the channel number returned when you initiated the DDE conversation.

RealLink provides four DDE server commands that return data to a client application:

| | |
|--------|--|
| Cursor | This returns the current position of the cursor on the RealLink terminal page. |
| Row | This returns all or part of a row of text displayed at a specified position on the terminal page. |
| Table | This returns the text displayed in a specified area of the terminal page, and formats it for inclusion in a table. |
| RxBuff | This returns the contents of the buffer in which RealLink receives data from the host. It can be used to obtain the result of a host command without that result being displayed in the RealLink window. |

Cursor Command

This returns the current position of the cursor on the RealLink terminal page.

| | |
|--------------|---|
| Item | Cursor |
| Return value | A string containing " <i>column</i> , <i>row</i> ". Positions are in characters, relative to the terminal page, where the top left-hand corner of the terminal page is position 0, 0. |

Example:

```
Item$ = "Cursor"
CurPos$ = DDERequest$(ChanNum, Item$)

Comma = InStr(CurPos$, ",")
Col = Val(Left$(CurPos$, Comma - 1))
Row = Val(Mid$(CurPos$, Comma + 1))

MsgBox "Column =" + Str$(Col) + Chr$(13) + "Row =" + Str$(Row)
```

Row Command

This returns all or part of a row of text displayed at a specified position on the terminal page.

| | |
|------|--|
| Item | Row <i>column</i> , <i>row</i> , <i>length</i> |
|------|--|

where

- *column* is the horizontal position of the first character required.
- *row* is the vertical position of the row required.
- *length* is the number of characters required.

The *column* and *row* parameters must be specified in characters, relative to the terminal page, where the top left-hand corner of the terminal page is position 0, 0.

Return value A string containing text from terminal page.

Example:

```
Col = 0
Row = 21
Length = 40

Item$ = "Row" + Str$(Col) + "," + Str$(Row) + "," + Str$(Length)

User$ = DDERequest$(ChanNum, Item$)

MsgBox User$, "RFWDDE"
```

Table Command

This returns the text displayed in a specified area of the terminal page, and formats it for inclusion in a table. Three formats are available: tab separated, comma separated and space separated.

Item **Table** *column , row , width , height , format*

where

- *column* is the horizontal character position of the left-hand edge of the area required, relative to the left-hand edge of the terminal page (position 0).
- *row* is the vertical character position of the top edge of the area required, relative to the top edge of the terminal page (position 0).
- *width* is the width of the area required in characters.
- *height* is the height of the area required in characters.
- *format* must be one of **TAB**, **COMMA** or **SPACE**.

Return value A string containing text from terminal page, formatted as requested. Lines of text are separated by carriage return characters (0x0D). Leading and trailing spaces are discarded and multiple embedded spaces are replaced by the specified format character: tab (0x09), comma or space.

RxBuff Command

This returns the contents of the buffer in which RealLink receives data from the host. It can be used to obtain the result of a host command without that result being displayed in the RealLink window.

Note: When using this command, you must use the TE Processing command described on page F-156 to ensure that RealLink retains the data received in the buffer until it is retrieved by RxBuff.

Item **RxBuff**

Return value The current contents of the RealLink receive data buffer.

Note: The data is sent to RealLink from the host in packets. This means that more than one call to RxBuff may be required to retrieve all the data. Also, while RealLink is waiting for the next packet, the buffer will be empty. It is therefore recommended that the RxBuff command be placed in a loop, which terminates when either a specified character is received, or if no data is returned within a specified time. This is illustrated in the example below.

Example:

```

REM Declare the timer function
Declare Function GetTickCount Lib "user" As Long

.
.
.

REM Route the data to the receive buffer
DDEExecute ChanNum, "TEProcessing 0"

REM Perform the host command
Item$ = ""
Data$ = "LISTF4" + Chr$(13)
DDEPoke ChanNum, Item$, Data$

REM Initialise strings for received data
RxBuff$ = ""          ' For received data
Result$ = ""         ' For cumulative total

REM Set the timeout to 10 secs
Timeout = GetTickCount + 10000

REM Loop until either the TCL prompt is received,
REM or the timeout expires
While Right$(RxBuff$, 1) <> ":" And GetTickCount < Timeout
  REM Fetch the contents of the buffer
  RxBuff$ = DDERequest$(ChanNum, "RxBuff")
  REM Append the buffer contents to the received
  REM data string
  Result$ = Result$ + RxBuff$
  REM If the data isn't NULL, reset the timeout
  If RxBuff$ <> "" Then Timeout = GetTickCount + 10000
Wend

REM Restore normal TE operation
DDEExecute ChanNum, "TEProcessing 1"

REM Do something with the received data
Insert Result$

```

Controlling RealLink

You can control RealLink by using a command that generates a DDE EXECUTE message. For example, in Word for Windows you would use the DDEExecute statement, and in Excel, the EXECUTE function. A command consists of an Item string containing the command name together with any parameters. You must also specify the channel number returned when you initiated the DDE conversation.

RealLink provides only one execute command, described below:

TE Processing Command

This allows you to specify whether data received from the host should be displayed on the terminal page or retained in a buffer until retrieved by an RxBuff request, or normal operation is restored.

Execute String TE Processing [0 | 1]

- If the parameter is set to 0, data processing is disabled. Data subsequently received from the host is retained in a buffer.
- If the parameter is set to 1, data processing is re-enabled. Any data in the buffer is displayed on the terminal page and normal operation is restored.

Normal operation is also restored when the DDE conversation is terminated.

Example:

```
REM Route the data to the receive buffer
DDEExecute ChanNum, "TEProcessing 0"
```

See also the RxBuff example on page F-155.

Index

/C command line switch 40
/L command line switch 151
/M command line switch 104

A

Abbreviations 14
About command 55
Adding
 macros to the Macro menu 103
 RealLink to other accounts 33
Advanced editing functions 45 to 48
ALT GR key 50
ALT key 44, 48, 74, 107, 111
ALT+1, ALT+2, etc. 41
ALT+DOWN ARROW 51, 81
ALT+END 50
ALT+F4 42, 49
ALT+HOME 50
ALT+INSERT 44
ALT+LEFT ARROW 81
ALT+PAGE DOWN 50
ALT+PAGE UP 49
ALT+RIGHT ARROW 82
ALT+UP ARROW 81
ALT+X 42
ANSI
 emulation 20, 74, 77
 escape sequences 114 to 35
API
 DataBasic 22
 defined 14
Append
 command 44
 escape sequence 127
Append Coordinates command 47
Application command, Help menu 55, 146
Application name, DDE 152
Applications
 controlling 57 to 58
 hybrid 23
 NewView 23
 running 57
 UIMS 23, 57
 Windows Help 146

Asynchronous connection 26
 problem solving 104
Asynchronous dialog 71 to 72
Asynchronous Port protocol 71
Asynchronous sessions, setting up 71
Attribute Mapping
 command 79
 dialog 80
Attribute processing 80
Auto Size command 78, 81
Auto-size, font 22, 78

B

Back pages - *see* History pages
Background colours 77, 80
Baud rate 35, 71
Bell 77
Break 58
Button, macro object 97, 124

C

Call, macro command 97, 98, 100, 107,
 110, 111, 114
Caps Lock escape sequence 127
CAPS LOCK key 40
 initial state 77
CapsLock, macro command 97, 98, 100,
 107, 110, 111
CFG file - *see* Configuration file
Changing
 host commands 52
 screen colours 79
Character set 73
Character translation attributes 138, 139
Clean-up command 57
Clear History escape sequence 127
Clipboard 43, 52, 53
 copying text to 44
 pasting text from 45
Closing RealLink 36, 42
Colours 77
Column selection 44
Columns, number of 76

- Command line editor - *see* Editing host commands
 - Command line parameters 31 to 32
 - /C switch 40
 - /L switch 151
 - /M switch 104
 - configuration file 40
 - Connect dialog 40
 - loading a macro 104
 - Command Stack command 52
 - Commands
 - editing - *see* Editing host commands
 - Help command 55
 - pre-loaded 52
 - Comments, script language 109
 - Communication parameters 70 to 72
 - Communications
 - command 70, 106
 - dialog 70, 71
 - Compose button, status bar 39, 50, 75
 - COMPOSE CHARACTER key (Prism terminal) 50
 - Configuration file 21, 66, 102
 - asynchronous connection 104
 - CAPS LOCK setting 77
 - command line parameter 31
 - Connect dialog 40
 - creating 66
 - DDE topic 150, 152
 - modifying 67
 - saving 68
 - Configuration, default 21, 69
 - Configure Table command 45
 - Configuring RealLink 31 to 32, 111 to 112
 - for DDE 151
 - Connect
 - command 36, 37, 40
 - dialog 31, 36, 40, 69
 - macro command 108, 97, 99, 100, 107, 110, 111, 114
 - Connect New RfW command 41
 - Connecting 36, 40
 - via a Terminal server 142 to 144
 - Connection menu
 - 1, 2, 3, 4 commands 41
 - Connect 36, 40
 - Connect New RfW 41
 - Disconnect 42
 - multiple sessions 41
 - Context-sensitive help 56, 146
 - Control menu 57 to 59
 - Controlling
 - applications 57 to 58
 - RealLink via DDE 155
 - Conventions 16
 - Copy
 - command 44
 - escape sequence 127
 - Copy Coordinates command 47
 - Copy Table
 - command 45
 - escape sequence 127
 - Copy Window
 - command 45
 - escape sequence 127
 - Copying text to the clipboard 44
 - CTRL key 47, 52, 107, 111
 - CTRL+ALT+PAGE DOWN 22
 - CTRL+ALT+PAGE UP 21
 - CTRL+BREAK 58, 59
 - CTRL+C 59
 - CTRL+END 44
 - CTRL+HOME 44
 - CTRL+INSERT 44, 52
 - CTRL+PAGE DOWN 22
 - CTRL+PAGE UP 21
 - CTRL+Q 104
 - CTRL+RETURN 51
 - CTRL+S 104
 - CTRL+SHIFT+RETURN 51
 - CTS 72
 - Cursor
 - DDE server command 153
 - keys 51, 52
 - options 77
 - position 153
- ## D
- Data entry
 - SovereignX 32
 - Data format 35, 72
 - DataBasic API 22
 - DDE 20, 150 to 156
 - application name 152
 - controlling RealLink 155
 - Cursor command 153
 - cursor position 153
 - defined 14
 - initiating a conversation 152
 - obtaining data from RealLink 152
 - Row command 153
 - RxBuff command 154
 - sending data to RealLink 152
 - server commands 152
 - Table command 154
 - TE Processing command 154, 156
 - terminating a conversation 152
 - using 152 to 156
 - DDE messages 150
 - EXECUTE 150, 155
 - INITIATE 150, 152
 - POKE 150, 152
 - REQUEST 150, 152
 - TERMINATE 150, 152
 - Default
 - configuration 21, 69
 - history lines 49

- Default (*continued*)
 HOST-WS filter 90
 Restore key 57, 58
 settings 40
 Windows printer 60
 WS-HOST filter 91
 Default protocol 36, 70
 Define, macro command 97, 100, 107,
 110, 111
 Delay, macro command 101
 DELETE key
 VT220 mode 74
 Deleting a macro from the disk 104
 Diacritical characters 39
 DIF format 92, 141
 Direct
 print mode 61
 printing 62
 Disable, macro command 97, 100, 101,
 107, 110, 111
 Disconnect
 command 42
 macro command 108, 102, 114
 DLL
 loading 31
 SovereignX data entry 32
 Documents, related 13
 Draw escape sequence 128
 Draw Rectangle escape sequence 130
 Draw, macro command 97, 100, 102, 107,
 110, 111
 Drop DTR on Exit 72
 DTR 72, 105
 Dynamic Data Exchange - *see* DDE
 Dynamic-link library - *see* DLL
- E**
- Edit menu 44 to 48
 Editing functions 43 to 48
 advanced 45 to 48
 Editing host commands 50 to 54
 changing a command 52
 Command Stack command 52
 pre-loaded commands 52
 repeating commands 51
 Replace 53 to 54
 selecting text to edit 52
 Editing macros 104
 Emulate print mode 61
 Enable bell 77
 Enable, macro command 97, 100, 103,
 107, 110, 111
 END debug command 57
 END key 44, 52
 VT220 mode 74
 End-of-line wrap 77
 Enlarge command 80, 81
- Error messages
see also Problem solving
 An error has occurred in script file
 'filename' 98
 Call stack full 99
 Cannot find CCIDDA21.DLL 106
 Cannot find CCITCP.DLL 106
 Cannot find font 102
 Cannot open file - filename 98
 Cannot open message file 102
 Cannot open the CFG file 102
 CONVERSION FILTER NOT FOUND 'filter'
 108
 COULDN'T OPEN FILE 'filename' 108
 COULDN'T READ ITEM 'itemname' 108
 COULDN'T READ ITEM 'RL.BP', 'filter' 108
 Error - Can only define Button 1 with
 Control or Shift 98
 Error - identifier already exists 98
 Error - identifier mismatch 98
 Filename will be truncated Ok? 103
 Hardware error or not present 104
 Illegal Filename - Device names cannot
 be used. 103
 INVALID CONVERSION FILTER FORMAT
 'filter' 109
 INVALID FILTER ITEM 108
 Invalid Stream 105, 106
 Invalid System Name 104
 Network Error, DDA -> ACI replug 106
 parse error near token 98
 parse error, expecting 'token' 98
 parser stack overflow 98
 Record size too large 107
 Stop - Can't find *DOSfile* 107
 Stop - *DOSfile* contains no data 107
 TRANSMISSION ERROR
 'filename, itemname' 108
 Unable to load CCIDDA21.DLL error 2
 106
 Unable to load CCITCP.DLL error 2 106
 Unable to transfer data - error 20
 (CONNECT) 107
 Unable to transfer data - error 54
 (DOSOPEN) 107
 Unable to transfer data - error 55
 (DISKWRITE) 107
 Unable to transfer data - error 60
 (BINARY) 107
 Unable to transfer data - error 61
 (ROSOPEN) 107
 Warning - 0 bytes transferred to *DOSfile*
 108
- Escape sequences 114 to 35
 Append 127
 Caps Lock 127
 Clear History 127
 Copy 127
 Copy Table 127

Escape sequences (*continued*)

- Copy Window 127
 - Draw 128
 - Draw Rectangle 130
 - Fill Rectangle 130
 - MDDPL 124
 - MDISTEM 131
 - MDRDS 133
 - MDSDF 124
 - Num Lock Control 133
 - Paste 133
 - PC Status Report 133
 - Process Attributes 134
 - RealLink 127 to 35
 - Screen Update 134
 - Set Selection 134
 - SGR 126
 - Stream 135
 - VT220 121 to 23
- Ethernet, defined 14
- Example
- files 30
 - macro 100 to 102
- Exec, macro command 97, 100, 103, 107, 110, 111
- EXECUTE, DDE message 150, 155
- Executing a script 98
- Exit
- command 36, 42
 - macro command 97, 100, 104, 107, 110, 111

F

F1 key 49

File menu

- Exit 36, 42
- New 66, 69
- Open 67
- Print Selection 62
- Print Window 62
- Printer Setup 60, 62
- Save 69
- Save As 67, 68

File Open dialog box 67

File transfer 25, 84 to 96

- Help command 55
- HOST-WS 89 to 90, 91
- LAN 84 to 88
- LanFTU command 84 to 88
- PASS-DOS 91 to 94
- problem solving 107
- Reality host utilities 89
- rz 95 to 96
- setting the DOS path 95
- SPASS-DOS 91 to 94
- sz 96
- UNIX host utilities 95

File transfer (*continued*)

- WS-HOST 90 to 91
- Zmodem 95 to 96

Files

- CFG - see Configuration file
- configuration - see Configuration file
- examples 30
- font 29
- Help 146
- macro 31
- QRGnn.HLP 56
- RFW.INI - see RFW.INI file
- RFWDE.DLL 151
- RFWDEF.CFG 29, 40, 69
- RFWEGA.FON 30
- RFWHELP.CPP 147
- RFWHELP.EXE 56, 146
- RFWPRINT.XLT 29
- RFWVGA.FON 30
- RL.BP 33, 137
- SETUP.EXE 29
- SNI configuration 86
- SovereignX DLLs 32
- SXPRINT.XLT 29
- WINHELP.EXE 146

Fill Rectangle escape sequence 130

Filters 137 to 40

- attribute 5 138, 139
- attribute 6 139, 140
- attributes 1 to 4 137
- attributes 7+ 139, 140
- character translation attributes 138, 139
- HOST-WS 89, 138
- LanFTU command 85
- LIST-FILTERS command 137
- PASS-DOS 92 to 93
- SPASS-DOS 92 to 93
- WS-HOST 91, 139

FIRST macro script 102, 103, 105, 104

Flow control

- asynchronous connections 35, 72
- script language 107

Font

- auto-size 22, 78
 - files 29
- Font menu 65, 80
- Auto Size 78, 81
 - Enlarge 80, 81
 - Save Window Position 69, 78, 81
 - Very Small 81

FOOTING clause 92

Foreground colours 77, 80

Function keys 48

- defining 99
- options 76
- Prism mode 74
- VT220 mode 75

G

Getting started 35 to 38
 Glossary 14
 GO, DataBasic debugger command 58
 Goto, macro command 107, 104
 GUI, defined 14

H

Hardware requirements 26
 Help
 context sensitive 56, 146
 files 146
 key 55, 56, 110
 menu 55, 146
 Reality 56
 window 55
 writing a Help application 146
 Hide, macro command 105
 History pages 20, 49, 76
 HOLD key (Prism terminal) 50
 HOME key 44, 52
 VT220 mode 74
 Horizontal scroll bar 21
 Host
 connection 26
 software 33
 Host Name or Serial Port 70, 71
 HOST-WS 25, 33, 89 to 90, 91
 default filter 90
 filters 89
 problem solving 108
 Hybrid application 23
 defined 14

I

Index command, Help menu 55
 INITIATE, DDE message 150, 152
 Initiating a DDE conversation 152
 InputText, macro command 106
 INSERT key
 VT220 mode 74
 Installing RealLink 27
 on a Network Server 26
 on a network workstation 29
 INTO clause 92
 Item size, Reality 33

K

Keyactions, macro object 105, 106
 Keyboard
 Help command 55
 selection mode 43

L

Labels, script language 108
 LAN sessions, problem solving 106
 LAN, defined 14
 LanFTU command 84 to 88
 browse dialog 87
 problem solving 107
 Line wrapping 77
 Lines, number of 76
 LIST-FILTERS, TCL command 137
 Load, macro command 105, 97, 100, 107,
 110, 111
 Loading a macro 103 to 4
 from the command line 31, 104
 Load-time errors, macros 98
 Logon workspace 33

M

Macro commands
 Call 97, 98, 100, 107, 110, 111, 114
 CapsLock 97, 98, 100, 107, 110, 111
 Connect 108, 97, 99, 100, 107, 110,
 111, 114
 Define 97, 100, 107, 110, 111
 Delay 101
 Disable 97, 100, 101, 107, 110, 111
 Disconnect 108, 102, 114
 Draw 97, 100, 102, 107, 110, 111
 Enable 97, 100, 103, 107, 110, 111
 Exec 97, 100, 103, 107, 110, 111
 Exit 97, 100, 104, 107, 110, 111
 Goto 107, 104
 Hide 105
 InputText 106
 Load 105, 97, 100, 107, 110, 111
 Maximise 97, 100, 107, 108, 110, 111
 Minimise 97, 100, 107, 110, 111
 Msg 108, 112, 114
 NumLock 97, 100, 107, 110, 111, 113
 Object...EndObject 105
 On...Goto 107, 114
 Password 115
 Restore 118
 Return 107, 98, 118, 119
 SendLine 97, 100, 107, 110, 111, 120
 SendText 97, 100, 107, 110, 111, 121
 Show 121
 Space 122, 123
 Timeout 122, 125
 Update 124
 WaitFor 108, 114, 116, 122, 125
 Macro errors 98 to 99
 see also Error messages
 load-time errors 98
 run-time errors 98
 tokens 99
 Macro files 31

- Macro menu
 - Macro Select 98
 - Save Macro List 104
 - Macro objects
 - Button 97, 124
 - Keyactions 105, 106
 - Menu 108
 - MenuItem 109
 - Mouseactions 105, 111
 - PopupMenu 105, 116
 - PulldownMenu 105, 116
 - Script 98, 105, 119
 - Toolbar 105, 97, 122, 123
 - Macro script, FIRST 102, 103, 105, 104
 - Macro Select command 98
 - Macros 98 to 99
 - adding to the Macro menu 103
 - deleting from the disk 104
 - editing 104
 - example 100 to 102
 - function-key definitions 99
 - loading 103 to 4
 - loading from the command line 31, 104
 - menu commands 98
 - mouse button definitions 99
 - removing from the Macro menu 104
 - Toolbars 99
 - Maximise
 - command 81
 - macro command 97, 100, 107, 108, 110, 111
 - Maximum workspace size 33
 - MDDPL escape sequence 124
 - MDISTEM escape sequence 131
 - MDRDS escape sequence 133
 - MDSDF escape sequence 124
 - Menu
 - macro object 108
 - separator item 109
 - Menu commands, defining 98
 - MenuItem, macro object 109
 - Messages, error - *see* Error messages
 - Minimise, macro command 97, 100, 107, 110, 111
 - Mode key 43, 110
 - Modifier keys 112
 - Mouse 43
 - selecting text to edit 52
 - shortcuts 48
 - Mouse buttons, defining 99
 - Mouseactions, macro object 105, 111
 - Msg, macro command 108, 112, 114
 - Multinational character set 73
 - Multiple connections 41
- ## N
- Nationality 73
 - Network
 - connections 36, 41
 - server 26
 - sessions 70
 - workstation 29
 - New command 66, 69
 - NewView application 23
 - Num Lock Control escape sequence 133
 - NUM LOCK key 40
 - NumLock, macro command 97, 100, 107, 110, 111, 113
- ## O
- Object definitions, script language 105
 - Object...EndObject, macro command 105
 - Obtaining data from RealLink via DDE, 152
 - Obtaining help 55
 - On...Goto, macro command 107, 114
 - Open command 67
- ## P
- P12 - *see* Prism emulation
 - P12/P14 terminal 73
 - PAGE DOWN key 22, 44, 49
 - VT220 mode 75
 - Page size 76
 - PAGE UP key 22, 44, 49
 - VT220 mode 74
 - Parity 35, 71
 - PASS-DOS 25, 33, 89, 91 to 94
 - DIF filter 141
 - filters 92 to 93
 - FOOTING clause 92
 - INTO clause 92
 - problem solving 108
 - Pass-through, print mode 61
 - Password, macro command 115
 - Paste
 - command 45
 - escape sequence 133
 - Pasting text from the clipboard 45
 - PAUSE key 50, 104
 - PC Status Report escape sequence 133
 - PCi
 - defined 14
 - Standard Network Interface 36, 41
 - Point size, used within terminal window 80, 81
 - POKE, DDE message 150, 152
 - PopupMenu, macro object 105, 116
 - PORT-DESPOOL, TCL command 20, 62
 - Pre-loaded
 - commands 52
 - replace strings 54

-
- Print mode 61
 - Print Selection command 62
 - Print Window command 62
 - Print Window Mode 61
 - Printer font, selecting 61
 - Printer Setup command 60, 62
 - Printer, selecting 60
 - Printing 20, 60 to 63
 - problems 102, 103
 - to a file 62
 - Prism emulation 20, 73
 - function keys 74
 - Problem solving 101 to 6
 - a blank page is ejected at the end of each printout 102
 - asynchronous communications 104
 - back-page does not work 102
 - characters are occasionally lost 105
 - double-clicking the RealLink Icon has no effect 102
 - file transfer 107
 - garbled response from the host 104
 - HOST-WS 108
 - LAN sessions 106
 - LanFTU 107
 - modem occasionally disconnects the line 105
 - no data is transferred 109
 - no response from the host 104
 - PASS-DOS 108
 - printing does not work 103
 - running RealLink 102
 - SHIFT key has no effect 103
 - SPASS-DOS 108
 - the last page of each printout is not ejected 103
 - WS-HOST 108
 - Process Attributes
 - command 80
 - escape sequence 134
 - Program Manager 31
 - Programmable keys options 76
 - Protocol
 - Asynchronous Port 71
 - default 36, 70
 - PulldownMenu, macro object 105, 116

 - Q**
 - QRGnn.HLP file 56

 - R**
 - REALBREAK environment variable 58
 - Reality
 - commands - see TCL commands
 - item size 33
 - systems 35
 - workspace recommendations 33
 - Reality Environment, defined 14
 - Reality Help 56
 - RealLink
 - adding to other accounts 33
 - configuration files 21
 - escape sequences 127 to 35
 - getting started 35 to 38
 - host software 25
 - problem solving 102
 - software 20
 - starting 36
 - starting 39
 - Related documents 13
 - Removing a macro from the Macro menu 104
 - Repeating
 - a replace operation 53
 - commands 51
 - Replace 53 to 54
 - pre-loaded replace strings 54
 - repeating 53
 - separator 53
 - Replaceable parameters, Help application 147
 - Reply as a P30 and not as a P12 73
 - REQUEST, DDE message 150, 152
 - Reserved words, script language 97
 - Reset button, Attribute Mapping dialog 80
 - Resetting the terminal emulator 59
 - Resource compiler 23
 - Restore
 - key 57
 - macro command 118
 - window position 78
 - Restore Key command 57, 58
 - Resume command 57
 - Return, macro command 107, 98, 118, 119
 - RFW command line 31
 - RFW.INI file 29, 31, 102, 103, 111 to 12
 - application help 55, 146
 - bitmaps directory 97, 100
 - blink rate 79
 - command stack size 51
 - Help key 56
 - loading DLLs 151
 - macro editor 104
 - macro list 104
 - macros directory 103, 107, 98
 - Mode key 43
 - pre-loaded commands 52
 - pre-loaded Replace strings 54
 - printer font 61
 - Reality help 56
 - Replace separator 53
 - Replace stack size 53, 54
 - Sovereign file transfer 107
 - RFWdde 152
 - RFWdde.DLL file 151

- RFWDEF.CFG file 29, 40, 69
- RFWEGA.FON file 30
- RFWHELP application 55
- RFWHELP.CPP file 147
- RFWHELP.EXE file 56, 146
- RFWPRINT.XLT file 29
- RFWVGA.FON file 30
- RL.BP file 137
 - RL.OPTIONS item 33
- Row, DDE server command 153
- RTS 72
- Running applications 57
- Run-time errors, macros 98
- RxBuff, DDE server command 154
- rz, UNIX command 95 to 96

- S**
- Save As command 67, 68
- Save command 69
- Save Macro List command 104
- Save Window Position command 69, 78, 81
- Screen
 - attributes 79
 - colours 79
- Screen Update escape sequence 134
- Script
 - executing 98
 - macro object 98, 105, 119
- Script language 105 to 9
 - comments 109
 - error messages 98 to 99
 - flow control 107
 - labels 108
 - object definitions 105
 - reserved words 97
 - strings 109
- Scroll bars 50, 77
 - horizontal 21
 - vertical 21, 22
- SCROLL LOCK key 43
- Scrolling 22
- Selecting
 - a printer 60
 - a printer font 61
 - columns of text 44
 - text 43
 - text to edit 52
- Send Restore Key As command 58, 59
- Sending data to RealLink, DDE 152
- SendLine, macro command 97, 100, 107, 110, 111, 120
- SendText, macro command 97, 100, 107, 110, 111, 121
- Separator item, menu 109
- Server commands, DDE 152
- Set CapsLock 77
- Set Coord. Format command 47
- Set Selection escape sequence 134
- Setting up
 - asynchronous sessions 71
 - network sessions 70
 - printers 61
- Setup menu 65
 - Attribute Mapping 79
 - Communications 70, 106
 - Process Attributes 80
 - Status Bar 40
 - Terminal Emulation 73
 - Terminal Preferences 22
- Setup program 27
- SETUP.EXE file 29
- SETUP-ACCOUNT, TCL command 33
- SGR escape sequence 126
- SHIFT key 43, 52, 56, 107, 111, 103
- SHIFT+DELETE 52
- SHIFT+INSERT 45, 52
- Show vertical scroll bar 77
- Show, macro command 121
- SNI
 - configuration file 86
 - defined 14
- Software installation 27
 - on a network workstation 29
- Software Key 28
- Software requirements 26
- Solid colour 80
 - defined 14
- Sovereign mode 20
- SovereignX DLLs 32
- Space, macro command 122, 123
- SPASS-DOS 25, 33, 89, 91 to 94
 - DIF filter 141
 - filters 92 to 93
 - FOOTING clause 92
 - INTO clause 92
 - problem solving 108
- Spoiled printing 62
- Starting RealLink 36, 39
- Statements - *see* Macro commands
- Status bar 39, 50
- Status Bar command 40
- Stop bits 35, 72
- Stream escape sequence 135
- Stream To File command 63
- Streaming to a file 63
- Strings, script language 109
- Strip Spaces command 45
- Swap text colours 77
- SXPRINT.XLT file 29
- System menu
 - Close 42
 - Command Stack 52
 - Maximise 81
- System messages 22
- sz, UNIX command 96

T

Table, DDE server command 154

TCL commands

- HOST-WS 25, 33, 89 to 90, 91
- LIST-FILTERS 137
- PASS-DOS 25, 33, 91 to 94
- PORT-DESPOOL 20, 62
- SETUP-ACCOUNT 33
- SPASS-DOS 25, 33, 91 to 94
- TERM 76
- WS-HOST 25, 33, 90 to 91

TCP/IP

- LAN connection 26
- network connections via 36, 70

TE Processing, DDE server command 154, 156

TERM, TCL command 76

Terminal emulation 35, 73, 104

- ANSI 74, 77
- command 73
- dialog 73
- preferences 76
- Prism 73
- VT220 74

Terminal page 22

- defined 14

Terminal Preferences command 22, 49

Terminal Preferences dialog 76 to 78

- Cursor 43

Terminal Reset command 59

Terminal server, connecting via 142 to 44

Terminal window 21

- defined 14
- height 22
- width 21

TERMINATE, DDE message 150, 152

Terminating

- applications 57
- DDE conversations 152

Text colours, swapping 77

Text cursor 77

Timeout, macro command 122, 125

Tokens, in macro error messages 99

Toolbar

- definition 99
- macro object 100, 105, 97, 122, 123

Tools menu

- LanFTU 84 to 88
- Set FTU Path 95
- Stream To File 63

Type size 80, 81

- auto-select 78

U

UIMS 20, 22

- DataBasic API 22
- defined 15

UIMS (*continued*)

- host software 25
- resource compiler 23

UIMS API, defined 15

UIMS application 23, 31, 57

- defined 15

UNIX commands

- rz 95 to 96
- sz 96

Update, macro command 124

User Interface Management System - *see* UIMS

Using

- DDE 152 to 56
- the mouse and the keyboard 43

V

Vertical scroll bar 21, 22, 50, 77

Very Small command 81

VGA display 21

VT220

- emulation 74
- escape sequences 121 to 23

W

WaitFor, macro command 108, 114, 116, 122, 125

Window, restore position 78

Windows Help application 146

WINHELP.EXE file 146

Workspace

- increment 33
- recommendations 33

Writing a Help application 146

- using replaceable parameters 147

WS-HOST 25, 33, 89, 90 to 91

- default filter 91
- filters 91
- item size 33
- problem solving 108

X

XON/XOFF 72

Z

Zmodem 95 to 96

- setting the DOS path 95